

# UV90 • 100V/120V/240V • LED



## Powerful blacklight fixture for special effect and themed environments.

- High power, 365nm UV A LED array, 15600mW, field replaceable
- 30,000 hour life to 70% of initial intensity, L70
- Hidden integral electronic driver, compatible with trailing edge electronic low voltage dimmers (dimnable to 5%); other dimming options available
- 10°, 25°, 40°, and 60° (90° field) Beam Spread Reflectors (available)
- DMX control option available
- Heavy duty aluminum housing
- Black stainless steel safety cable with integral snap hook (included)
- Integrated double gate accessory holder capable of holding either a barndoor or hood and a glass accessory lens
- UV Lens UV90 blocks all visible light while allowing UV transmission (included)
- Double clutch locking for vertical focusing and tooled locking for horizontal focusing
- Finish: LSI Black
- Fixture weight: 10 lbs

## FIXTURE PART NUMBERS

Please review the **ORDERING INFORMATION** section on the next page as well as the **MOUNTING OPTIONS** on page 3 to create a part number for each fixture that specifies the following:

- LED Module
- LED Rating
- Optic (mm/beam spread)
- Fitting/Controls (Dimming)
- Voltage
- Finish
- Accessory (optional)
- Starter Harness Plug

### PART NUMBER

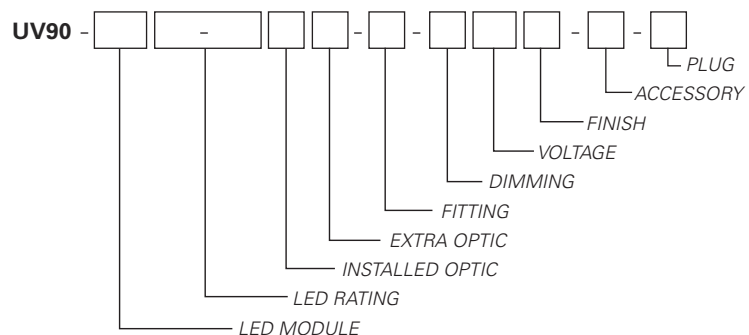

Example Part Number: **UV90-N0916-361025-3A-DMX120B-BDHD-P1** is a UV Blacklight fixture with a high power, UV A (9) LED array, 15600mW/365 Wavelength/50 Watt LED rating, 10° Optic, 25° Extra Optic, 3A Mega Clamp Fitting. The 120V fixture in black finish is equipped with DMX Address Knobs, DMX compatible control gear, a P1 Starter Harness Plug (NEMA 5-15P, 125V Max) and UV lens. Barndoor and Hood are optional accessories.

# UV90 • 100V/120V/240V • LED

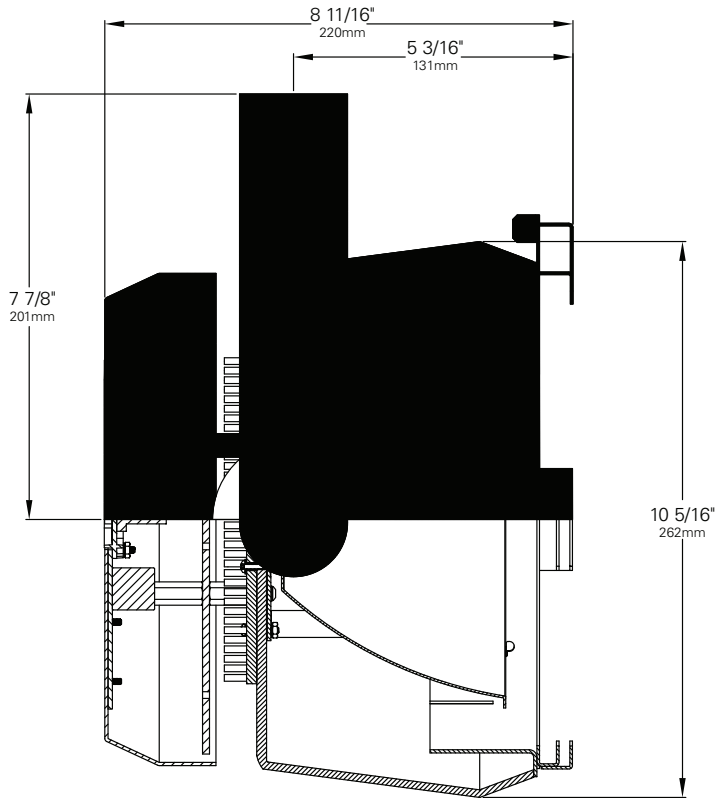

### DRIVER TYPE (Electronic)

Input Power (A) - 100V	0.50
Input Power (A) - 120V	0.41
Input Power (A) - 240V	0.23
Wattage	50
Power Factor - 115V	.95

### LED ORDERING INFORMATION

#### Base Fixture Model

- UV90-N09 = UV A (9) LED Array

#### LED Rating (mW/Wavelength/Wattage)

- 16-36 = 15600/365/50

#### Installed Optic (Choose 1)

- 10 = 178mm/10°
- 25 = 178mm/25°
- 40 = 178mm/40°
- 60 = 178mm/60°

#### Extra Optic (Choose 1)

- 10 = 178mm/10°
- 25 = 178mm/25°
- 40 = 178mm/40°
- 60 = 178mm/60°

#### Fitting/Controls (Dimming)

- 2A-DMX = Unistrut Mount & DMX (1%)
- 2A-ELV = Unistrut Mount & ELV (5%)
- 2B-DMX = Base Plate Mount & DMX (1%)
- 2B-ELV = Base Plate Mount & ELV (5%)
- 3A-DMX = Mega Clamp Fitting & DMX (1%)
- 3A-ELV = Mega Clamp Fitting & ELV (5%)

#### Voltage

- 100 = 100V     120 = 120V     240 = 240V

#### Finish

- B = Black

#### Accessory (Optional)

- BD = Barndoor
- HD = Hood

#### Starter Harness Plug

- P1 = NEMA 5-15P (125V Max)
- P2 = NEMA L5-15P (125V Max)
- P3 = NEMA L6-20P (250V Max)
- P4 = NEMA L5-20P (125V Max)
- P5 = 10 FT, No Plug (250V Max)

#### Example Part Number:

**UV90-N09 16-36 1025-3A-DMX 120B - BDHD - P1**

FIXTURE MODEL    LED RATING    OPTIC    FITTING/DIMMING    VOLTAGE/FINISH    ACCESSORY    PLUG

# UV90 • MOUNTING OPTIONS

FITTING	SIDE VIEW	PROFILE VIEW
---------	-----------	--------------

**2A Unistrut Fitting**

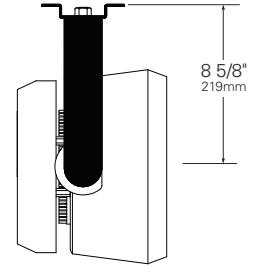
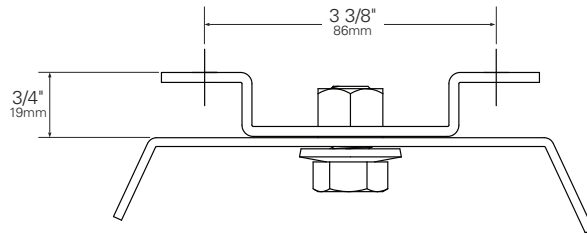

**2B Base Plate Fitting**

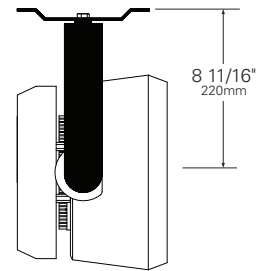
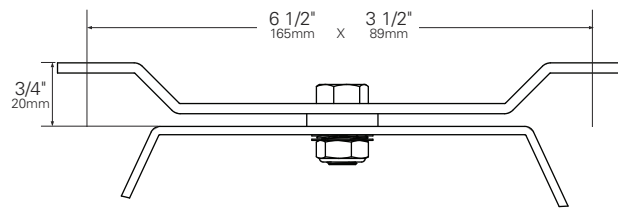

**3A Mega Clamp Fitting**

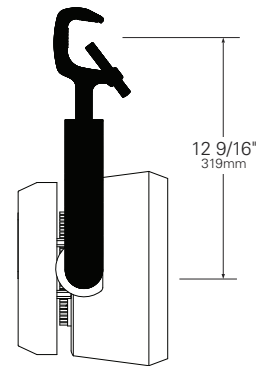
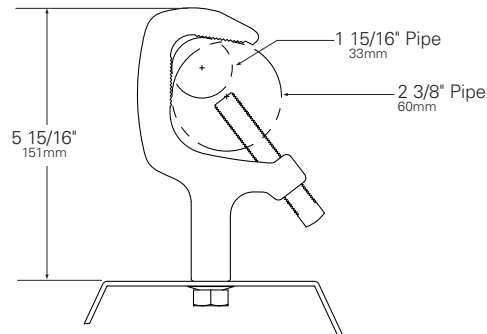

# UV90 • ACCESSORIES

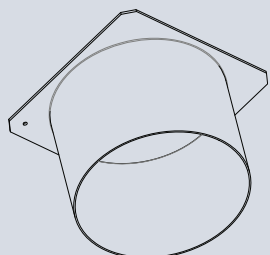

### HOOD UV90

6 inch deep hood. Controls spill light and glare. Black finish.

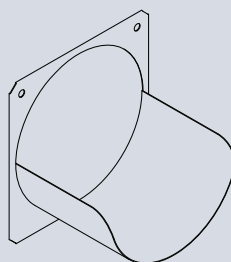

### HALF HOOD UV90

6 1/16 inch deep half hood. Controls spill light and glare. Black finish.

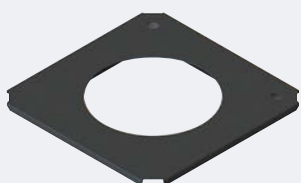

### DIRT SHIELD UV90

Clear glass in sheet metal frame to prevent dirt and debris from going inside the fixture.

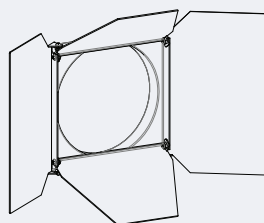

### BARNDOOR UV90

4-way individually adjustable blades for control of light beam. Black finish.

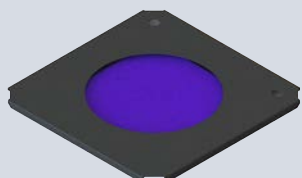

### UV LENS UV90

Narrow band pass filter blocks all visible light while allowing UV transmission.

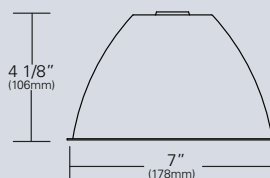

### UV90-10-REF-CLR (178MM/10°)

Faceted aluminum optic. Tool-less, twist and lock installation. Aluminized finish.

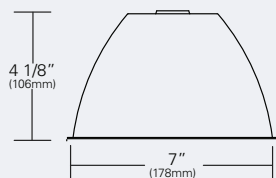

### UV90-25-REF-CLR (178MM/25°)

Faceted aluminum optic. Tool-less, twist and lock installation. Aluminized finish.

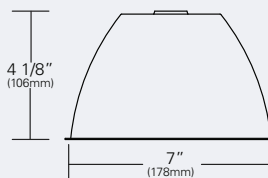

### UV90-40-REF-CLR (178MM/40°)

Faceted aluminum optic. Tool-less, twist and lock installation. Aluminized finish.

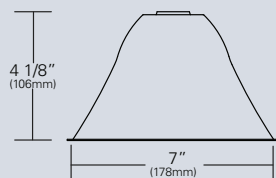

### UV90-60-REF-CLR (178MM/60°)

Faceted aluminum optic. Tool-less, twist and lock installation. Aluminized finish.