

LP4 • 120/277V • LED • COB



This versatile spotlight creates a high intensity shaft of light that is perfect for long-throw applications.

- 10° optic produces 90,000 CBCP with 7500 lumens at 78 watts
- System efficiency up to 81 lumens/watt
- Exceeds ANSI specifications by maintaining extremely tight color consistency over the life of the fixture
- Tested to LM79 and LM80 Protocols
- 50,000 hour life to 70% lumen output, L₇₀ at 95°F max ambient
- Hidden integral electronic driver, compatible with trailing edge electronic low voltage dimmers (dimnable to 5%)
- Choice of beam spread (interchangeable optics)
- Color Rendering Index (CRI) 80, 90, 98
- Color consistency, 2 MacAdam ellipse
- No UV or IR emissions; no mercury or lead
- On/off safety switch (on most mounting types)
- Field replaceable LED module
- Sturdy aluminum housing
- Toolless vertical and horizontal focusing
- External accessory cartridge
- 36" stainless steel safety cable included
- Finishes: LSI Black, White, and Silver
- Fixture weight: 9 lbs

FIXTURE PART NUMBERS

Please review the **ORDERING INFORMATION** section on the next page as well as the **MOUNTING OPTIONS** on page 3 to create a part number for each fixture that specifies the following:

- LED Rating
- Color Temperature
- Optic (mm/beam spread)
- Fitting/Controls (Dimming)
- Voltage
- Finish

PART NUMBER

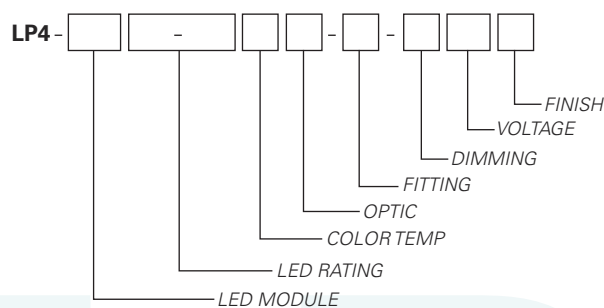

Example Part Number: **LP4-C1965-903510-00-TE120W** is a fixture with a high power, 19mm COB LED, 6500 Lumen/90 CRI/78 Watt LED rating, 3500K Color Temperature, 180mm 10° Optic, 00Track fitting with Trailing Edge group dimming capability, 120V and a White finish.

LP4 • 120/277V • LED • COB

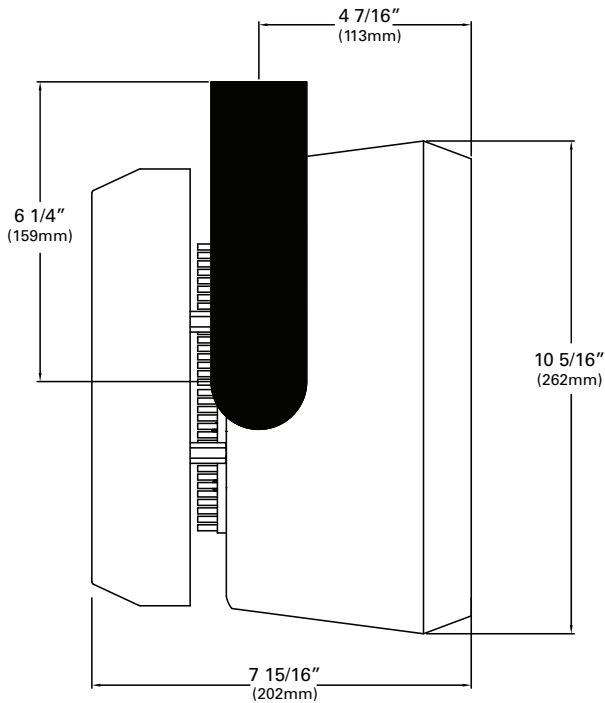

DRIVER TYPE (Electronic)

| | |
|------------------------|------|
| Input Power (A) - 120V | 0.65 |
| Input Power (A) - 277V | 0.28 |
| Wattage | 78 |
| Power Factor - 115V | 0.92 |

Chromaticity Specifications

| LED | R _a -CRI | R _f -Fidelity | R _g -Gamut Area |
|-----|---------------------|--------------------------|----------------------------|
| C19 | 80 | 83 | 96 |

ORDERING INFORMATION

Base Fixture Model

LP4-C19 (19mm COB LED)

LED Rating (Lumens/CRI/Wattage)

61-98 = 6100/98/78 65-90 = 6500/90/78
 75-80 = 7500/80/78

Color Temperature

27 = 2700K 30 = 3000K
 35 = 3500K 40 = 4000K

Optic

10 = 180mm/ 10°* 25 = 180mm/ 25°
 40 = 180mm/ 40° 60 = 180mm/ 60°

*Hood LP4 recommended when using 10° reflector if limited field angle is required

Fitting/Controls (Dimming)

- 00-TE = Track Fitting & Trailing Edge (5%)
- 00-LE = Track Fitting & Leading Edge (5% - 120V only)
- 0E-ED = Track Fitting with Integral Dimmer (0.1%)
- 00EF-TE = Security/Worklight Track Fitting & Trailing Edge (5%)
- 2G-TE = Universal Fitting & Trailing Edge (5%)
- 2G-LE = Universal Fitting & Leading Edge (5% - 120V only)
- 2G-DX = Universal Fitting & DMX (<1%)
- 3G-TE = Pipe Clamp Fitting & Trailing Edge (5%)
- 3G-LE = Pipe Clamp Fitting & Leading Edge (5% - 120V only)
- 3G-DX = Pipe Clamp Fitting & DMX (<1%)
- 5A-TE = Canopy Fitting & Trailing Edge (5%)
- 5A-LE = Canopy Fitting & Leading Edge (5% - 120V only)
- 5A-DX = Canopy Fitting & DMX (<1%)
- 5A-10 = Canopy Fitting & 0-10V (0.1%)
- 5A-ED = Canopy Fitting with Integral Dimmer (0.1%)

- Coiled Cord is available only with **2G** and **3G** mounting options. Change 2G to **2C** and 3G to **3C**. (When a coiled cord is not specified, a straight cord is provided.)

Voltage

120 = 120V 230 = 220-240V 277 = 277V

Finish

B = Black W = White S = Silver

| | | | | | |
|----------------|--------------|------------|-------------------|-----------------|----------------|
| LP4-C19 | 65-90 | 35 | 10 - 00-TE | 120 | W |
| FIXTURE MODEL | LED RATING | COLOR TEMP | OPTIC | FITTING/DIMMING | VOLTAGE FINISH |

Other Options (Consult Factory):

- Custom Finish, RAL palette

LP4 • MOUNTING OPTIONS

FITTING

SIDE VIEW

PROFILE VIEW

**00 Track Fitting/
00EF Security/Worklight
Fitting**

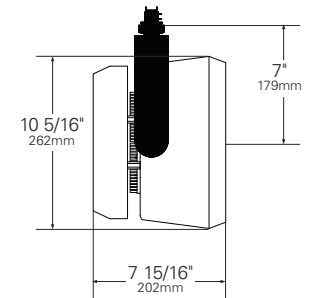
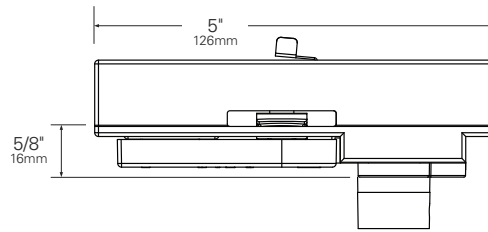

**0E-ED Track Fitting
with Integral Dimmer**

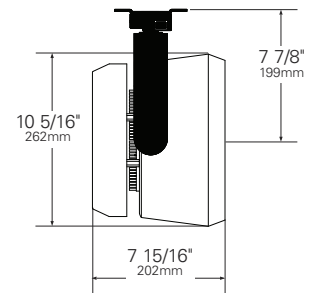
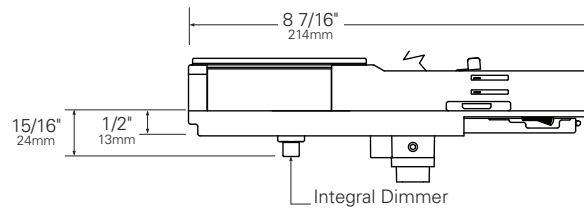

2G Universal Fitting

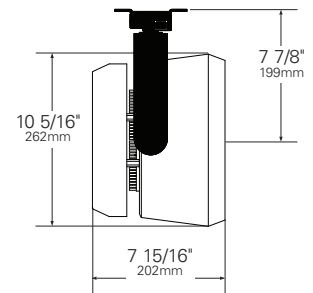
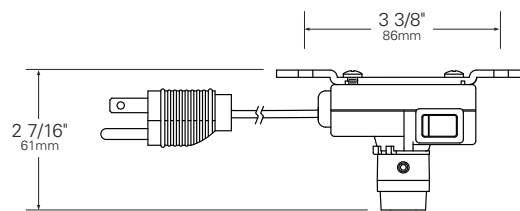

3G Pipe Clamp Fitting

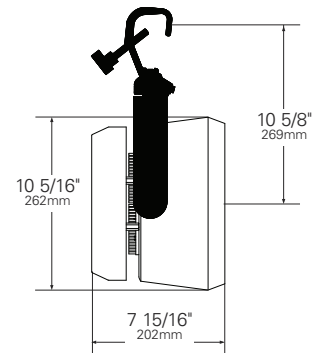
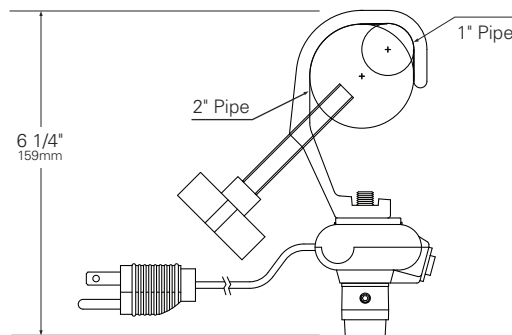

**5A Canopy Fitting
with TE, LE, DX,
and 0-10V Dimming**

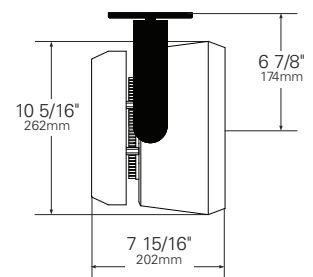
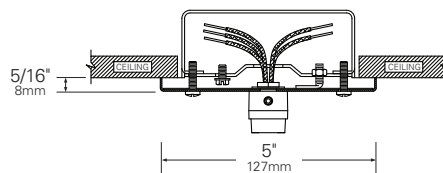

**5A-ED Canopy Fitting
with Integral Dimmer**

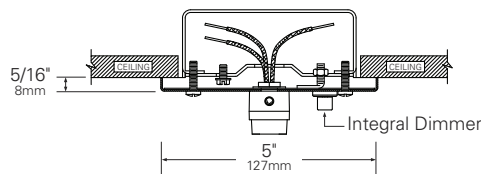

LP4 • PERFORMANCE

The performance characteristics of the LP SuperSPOT family of products can be customized based on the LED module and the optic selected.

Each available LED module is defined by four characteristics – the color rendering index (CRI), the correlated color temperature (CCT), the power that it uses (watts), its “available lumens” and beam spread. Note that available lumens is a theoretical value that represents the light output of the module on its own – no fixture or optic attached.

In the LSI part number, the LED module is specified with a letter and a number that immediately follow the product series number. For example, in the part number LP4-C1975-803010-00-TE120B, the “C1975-803010” represents an LED module with an output of 7500 lumens, a CRI of 80, a power usage of 78 watts, color temperature of 3000K and a 10-Degree beam.

Additional parameters, such as Center Beam Candle Power (CBCP), Delivered Lumens, and Efficiency (Lumens per Watt) are all shown in a table that is organized by LED module and optic combination.

| CBCP = Center Beam Candle Power | | | | |
|---------------------------------|-------------------|--------|--------|-------|
| LED Module | Optic (Reflector) | | | |
| Lumens/CRI/Wattage | 10° | 25° | 40° | 60° |
| 7500/80/78 | 90,000 | 18,900 | 10,800 | 6,800 |
| 6500/90/78 | 78,000 | 16,380 | 9,360 | 5,900 |
| 6100/98/78 | 73,200 | 15,370 | 8,780 | 5,530 |

| Delivered Lumens | | | | |
|--------------------|-------------------|-------|-------|-------|
| LED Module | Optic (Reflector) | | | |
| Lumens/CRI/Wattage | 10° | 25° | 40° | 60° |
| 7500/80/78 | 6,500 | 6,500 | 6,500 | 6,500 |
| 6500/90/78 | 5,600 | 5,600 | 5,600 | 5,600 |
| 6100/98/78 | 5,300 | 5,300 | 5,300 | 5,300 |

| Efficiency = Lumens Per Watt | | | | |
|------------------------------|-------------------|-----|-----|-----|
| LED Module | Optic (Reflector) | | | |
| Lumens/CRI/Wattage | 10° | 25° | 40° | 60° |
| 7500/80/78 | 83 | 83 | 83 | 83 |
| 6500/90/78 | 72 | 72 | 72 | 72 |
| 6100/98/78 | 68 | 68 | 68 | 68 |

| LED Module Lumens/CRI/Wattage SKU Code | |
|--|------|
| Nominal Fixture Power (+/- 20%), Watts | 78 |
| Maximum Inrush Current Amps | 10 |
| Minimum Power Factor | 0.92 |

Inrush current is instantaneous current drawn by the LED only when fixture is initially powered on or instantaneously changed from full dim to full bright. For more details see Dimming Application Sheet, IS-0119.

LP4 • PHOTOMETRIC DATA

PHOTOMETRIC DATA
LED Rating: 75-80

LP4 Series
Beam Spread (minimum) **10°**
Center Beam Candlepower **90,000**
CRI **80**

LP4 Series
Beam Spread (minimum) **25°**
Center Beam Candlepower **18,900**
CRI **80**

LP4 Series
Beam Spread (minimum) **40°**
Center Beam Candlepower **10,800**
CRI **80**

LP4 Series
Beam Spread (minimum) **60°**
Center Beam Candlepower **6,800**
CRI **80**

All Max. Footcandles at 0° Beam Axis

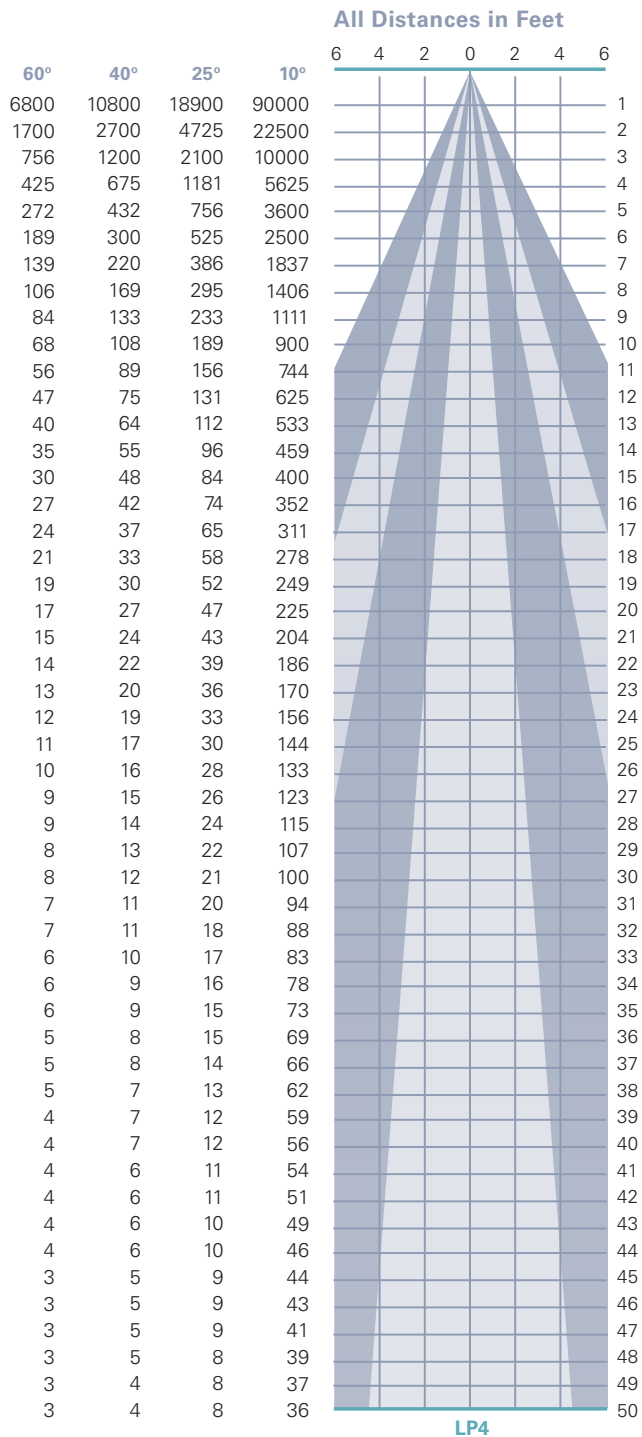

LP4 • ACCESSORIES

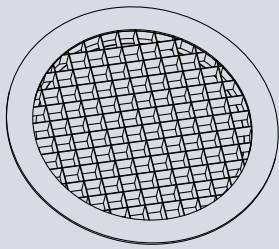

LOUVER LP4B
45° cutoff is obtained by using cells that are 1/2" x 1/2" x 1/2" deep to control spill light and glare.

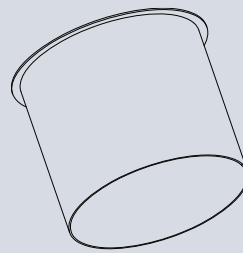

HOOD LP4B
6 inch deep hood. Interior flocking included to control spill light and glare. Black finish.

Recommended when using 10° reflector if limited field angle is required.

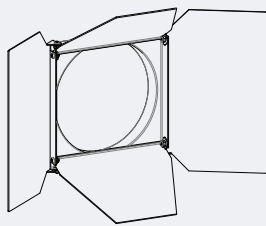

BARNDOOR LP4B
4-way individually adjustable blades for control of light beam. Black finish.

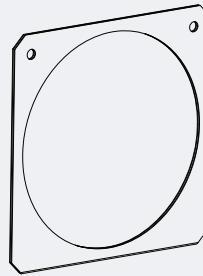

GEL HOLDER LP4
Can hold up to 3 gels in holder.

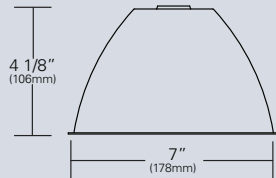

LP4-10-REF-CLR* (180MM/10°)
Faceted aluminum optic. Tool-less, twist and lock installation. Specular finish.

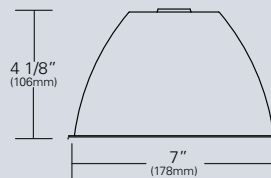

LP4-25-REF-CLR (180MM/25°)
Faceted aluminum optic. Tool-less, twist and lock installation. Specular finish.

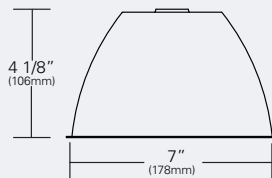

LP4-40-REF-CLR (180MM/40°)
Faceted aluminum optic. Tool-less, twist and lock installation. Specular finish.

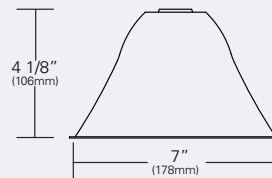

LP4-60-REF-CLR (180MM/60°)
Faceted aluminum optic. Tool-less, twist and lock installation. Specular finish.

LP4 • GELS

As the foremost innovator in accent lighting, LSI offers a complete range of pre-cut Gels to modify the spread and color of light.



LP4 SPREAD GELS

| Size: LP4 (8-7/8 x 8-7/8 Square) | Spread Gel |
|-------------------------------------|-----------------------|
| GEL-L1-LP4 | 1° Spread Gel |
| GEL-L5-LP4 | 5° Spread Gel |
| GEL-L10-LP4 | 10° Spread Gel |
| GEL-L20-LP4 | 20° Spread Gel |
| GEL-L30-LP4 | 30° Spread Gel |
| GEL-L40-LP4 | 40° Spread Gel |
| GEL-L60-LP4 | 60° Spread Gel |
| GEL-L80-LP4 | 80° Spread Gel |
| GEL-L30X5-LP4 | 30° by 5° Spread Gel |
| GEL-L40X1-LP4 | 40° by 1° Spread Gel |
| GEL-L60X1-LP4 | 60° by 1° Spread Gel |
| GEL-L60X10-LP4 | 60° by 10° Spread Gel |
| GEL-L75X45-LP4 | 75° by 45° Spread Gel |
| GEL-L90X60-LP4 | 90° by 60° Spread Gel |
| GEL-R101-LP4 | Beam Softener |

LP4 COLOR GELS

| Size: LP4 (8-7/8 x 8-7/8 Square) | Gel Color | Size: LP4 (8-7/8 x 8-7/8 Square) | Gel Color |
|-------------------------------------|-------------------|-------------------------------------|---|
| GEL-R2-LP4 | Bastard Amber | GEL-R312-LP4 | Canary |
| GEL-R7-LP4 | Pale Yellow | GEL-R331-LP4 | Shell Pink |
| GEL-R12-LP4 | Straw | GEL-R383-LP4 | Sapphire Blue |
| GEL-R13-LP4 | Straw Tint | GEL-R397-LP4 | Pale Grey |
| GEL-R14-LP4 | Medium Straw | GEL-R2001-LP4 | Storaro Red |
| GEL-R21-LP4 | Golden Amber | GEL-R2004-LP4 | Storaro Green |
| GEL-R25-LP4 | Orange Red | GEL-R2009-LP4 | Storaro Violet |
| GEL-R26-LP4 | Light Red | GEL-R3202-LP4 | Full Blue |
| GEL-R27-LP4 | Medium Red | GEL-R3204-LP4 | Half Blue |
| GEL-R57-LP4 | Lavender | GEL-R3206-LP4 | Third Blue |
| GEL-R62-LP4 | Booster Blue | GEL-R3216-LP4 | Eighth Blue (Boosts 3200K to 3300K) |
| GEL-R71-LP4 | Sea Blue | GEL-R3318-LP4 | Tough 1/8 Minusgreen |
| GEL-R72-LP4 | Azure Blue | GEL-R3410-LP4 | Roscosun (1/8 CTO) (Reduces 5500K to 4900K) |
| GEL-R91-LP4 | Primary Green | GEL-R3441-LP4 | Full Straw (CTS) |
| GEL-R97-LP4 | Light Grey | GEL-R3443-LP4 | Quarter Straw (CTS) |
| GEL-R98-LP4 | Medium Grey | GEL-R4330-LP4 | CalColor 30 Cyan |
| GEL-R101-LP4 | Light Frost | GEL-R4415-LP4 | CalColor 15 Green |
| GEL-R104-LP4 | Tough Silk | GEL-R4490-LP4 | CalColor 90 Green |
| GEL-R119-LP4 | Lt. Hamburg Frost | GEL-R4860-LP4 | CalColor 60 Pink |
| GEL-R121-LP4 | Blue Diffusion | GEL-R4890-LP4 | CalColor 90 Pink |
| GEL-R305-LP4 | Rose Gold | GEL-R4930-LP4 | CalColor 30 Lavender |