

# UV LINEAR • 120/240V • LED



DMX version displayed

## Portable blacklight fixture for seamless general wash or wall grazing

- High power, 365nm UV A LED array, field replaceable
- 30,000 hour life to 70% of initial intensity, L70
- Various beam spread optics (available, not field changeable)
- Available in 1 FT, 2 FT, and 4 FT lengths
- Mounting capabilities include adjustable trunion mounting feet or mega pipe clamp
- DMX/RDM available with two 5-pin XLR connectors (1 male/1 female) to allow for daisy chaining the DMX signal, compatible with ANSI E1.11-2008 standard
- Local dimming from 0-100% available on DMX-enabled fixture via DMX address buttons
- Double clutch locking for vertical focusing
- Supplied with a Neutrik powerCONTRU1 TOP connector (250V 15AMP) grounding / locking plug with 6 FT 3-wire cord
- Additional extension cables are available in 5 FT, 10 FT and 15 FT lengths, capable of daisy chaining fixtures up to 80 feet
- Heavy duty aluminum housing
- Black stainless steel safety cable with integral snap hook (included)
- Integral UV Lens blocks all visible light while allowing UV transmission
- Finish: LSI Black
- Fixture weight: 3 lbs. (1 FT), 6 lbs. (2 FT), 11 lbs. (4 FT)

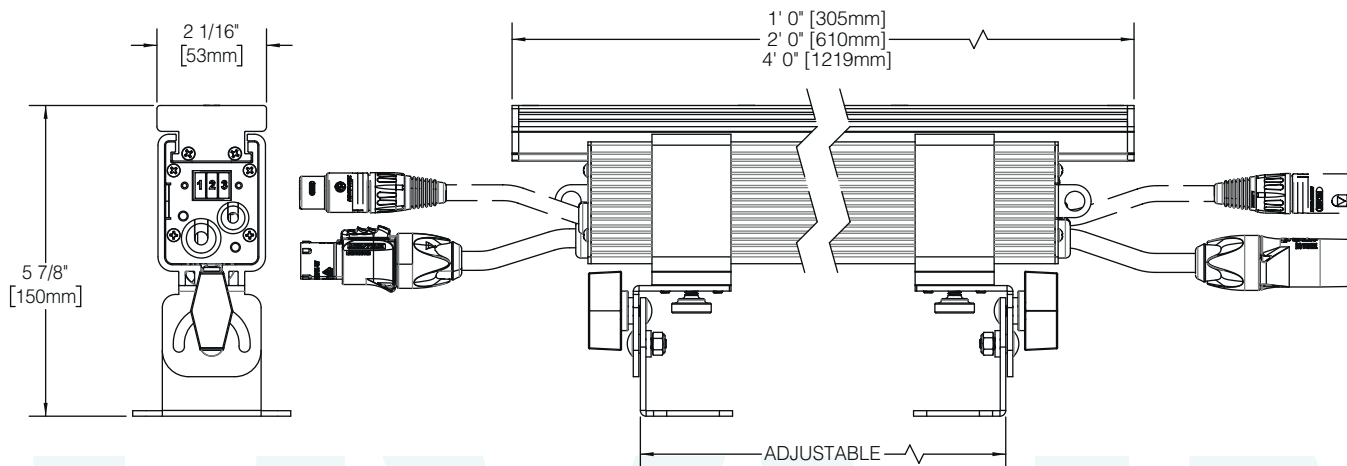

# UV LINEAR • 120/240V • LED

## ORDERING INFORMATION

### Base Fixture Model

- UVLIN

### LED Model and LED Rating (Mw/Wavelength/Wattage)

- N1F = 5 LED Linear Strip, 1 FT  
73-36 = 7300/365/22
- N2F = 10 LED Linear Strip, 2 FT  
146-36 = 14,600/365/44
- N4F = 20 LED Linear Strip, 4 FT  
292-36 = 29,200/365/88

### Optic (Vertical x Horizontal, not field changeable)

- 10x30 = 10 x 30 Degree
- 10x60 = 10 x 60 Degree
- 15x30 = 15 x 30 Degree
- 25x40 = 25 x 40 Degree
- 30x10 = 30 x 10 Degree
- 30x15 = 30 x 15 Degree
- 40x25 = 40 x 25 Degree
- 60x10 = 60 x 10 Degree
- 60 = 60 Degree

### Fitting

- TR = Trunion       3A = Mega Clamp

### Controls (Dimming)

- DMX = DMX (<1%)       ELV = ELV (5%)

### Voltage

- 100 = 100V       120 = 120V       240 = 240V

### Finish

- B = Black

### Starter Harness Plug

- P1 = 6 FT. NEMA 5-15P (125V MAX)
- P2 = 6 FT. NEMA L5-15P (125V MAX)
- P3 = 6 FT. NEMA L6-20P (250V MAX)
- P4 = 6 FT. NEMA L5-20P (125V MAX)
- P5 = 10 FT, No Plug (250V MAX)

### Example Part Number:

**UVLIN - N1F7-36 10x30 - TR - DMX 120B - P1**

FIXTURE MODEL      LED MODULE/LED RATING      OPTIC      FITTING      CONTROLS      VOLTAGE      PLUG

# UV LINEAR • 120/240V • BEAM ANGLE OPTIONS

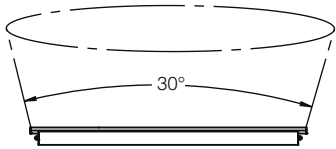
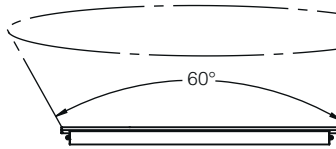
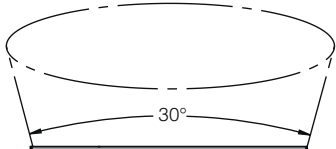
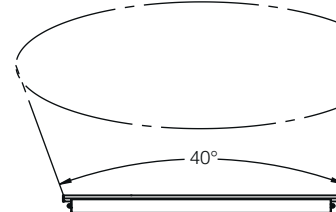
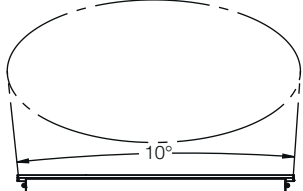
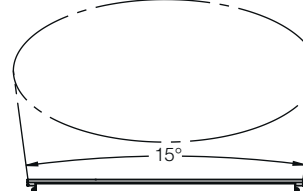
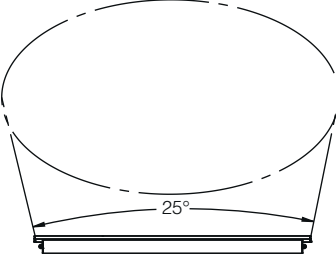
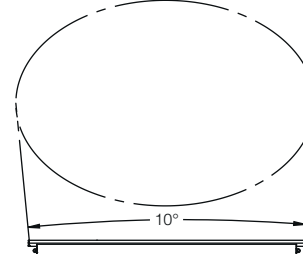
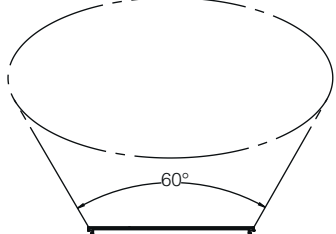
|  |   |
|--|---|
| <p style="text-align: right;"><b>10x30 Degree*</b></p>    | <p style="text-align: right;"><b>10x60 Degree*</b></p>    |
| <p style="text-align: right;"><b>15x30 Degree*</b></p>    | <p style="text-align: right;"><b>25x40 Degree*</b></p>    |
| <p style="text-align: right;"><b>30x10 Degree*</b></p>   | <p style="text-align: right;"><b>30x15 Degree*</b></p>   |
| <p style="text-align: right;"><b>25x45 Degree*</b></p>  | <p style="text-align: right;"><b>60x10 Degree*</b></p>  |
| <p style="text-align: right;"><b>60 Degree*</b></p>     |   |

\*Not field changeable