

LX2038 • 120/277V • TUNABLE WHITE 9MM

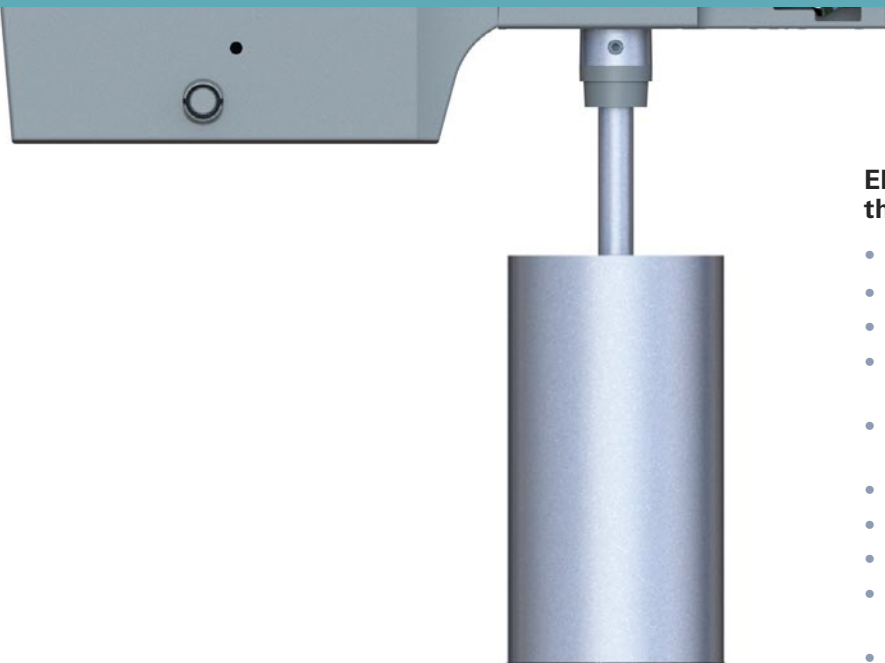

Elegant fixed downlight designed specifically for the most demanding architectural applications

- Designed for a Tunable White LED module up to 15 watts
- Extremely tight color consistency: 3 MacAdam Ellipses
- System efficiency up to 37 lumens/watt
- 55,000 hour life to 70% lumen output, L70 at 95°F max ambient
- Field interchangeable optics (16°–40°) modify the beam spread distribution
- Tunable White from 2700K to 6500K
- Color Rendering Index (CRI) of 92 min.
- Tested to LM79 and LM80 Protocols, TM-30 available
- Hidden custom driver compatible with Integral Dimming down to <1%
- Accessory holder accepts up to two size-AAA LSI filters and accessories
- Optional Cross Baffle accessory holder available
- Sturdy die-cast aluminum housing
- No UV or IR emissions; no mercury or lead
- On/off safety switch (PT5 Track fitting)
- Finishes: LSI Black, White, and Silver
- Fixture weight: 3 lbs
- All modules are field replaceable
- Fixed center stem
- Maximum stem length is 48"

FIXTURE PART NUMBERS

Please review the **ORDERING INFORMATION** section on the next page as well as the **MOUNTING OPTIONS** on page 3 to create a part number for each fixture that specifies the following:

- LED Module
- LED Rating
- Color Temperature
- Optic- mm/beam spread
- Fitting/Controls (Dimming)
- Voltage
- Finish

PART NUMBER

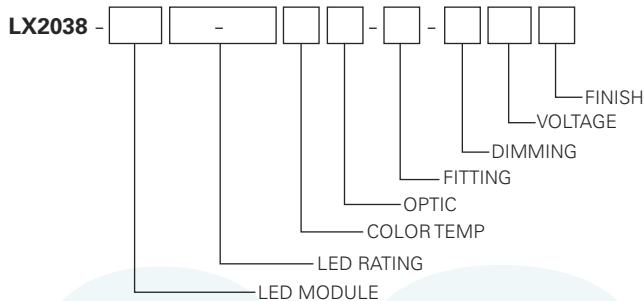

Example Part Number: **LX2038-B0910-92TWP1-PT5-ED120W** is a fixture with a Tunable White 9mm LED module, 1000 Lumen/92 CRI/15 Watt LED rating, Tunable White 2700K-6500K Color Temperature, 50mm 16° Optic, OE Track fitting with Integral Dimming/CCT setting capability, 120V and a White finish.

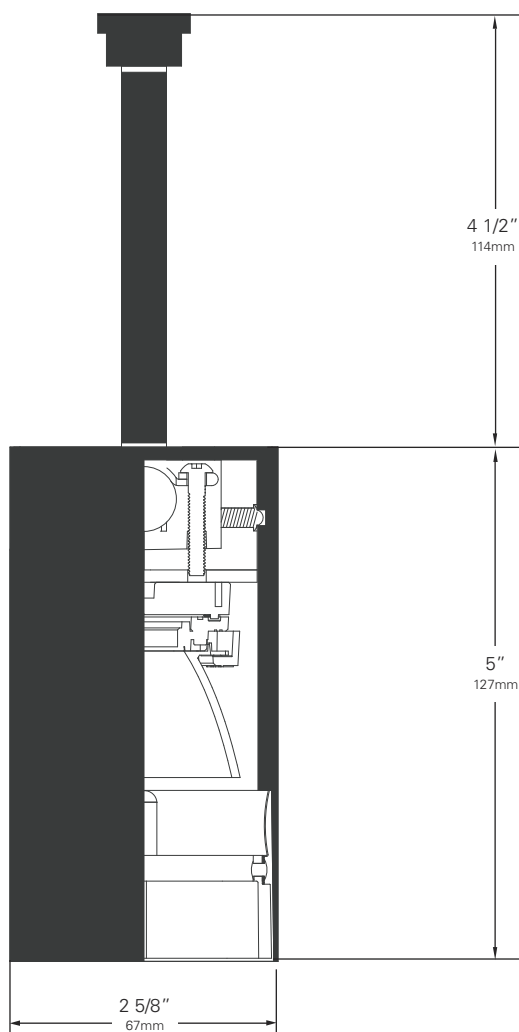
LX2038 • 120/277V • TUNABLE WHITE 9MM**TUNABLE WHITE 9MM
ORDERING INFORMATION****Base Fixture Model**

- LX2038-B09 (Tunable White 9mm)

LED Rating (Lumens/CRI/Wattage)

- 10-92 = 1000/92/15

Color Temperature

- TW= 2700K to 6500K
Preset CCT Color Points:
2700K, 3000K, 3500K
4000K, 5700K, 6500K

Optic

- P1 = 50mm/ 16° color mixing
 P2 = 50mm/ 24° color mixing
 P4 = 50mm/ 40° color mixing

Fitting/Controls (Dimming)

- PT5-ED = Track Fitting & Integral Dimmer (<1%)

Voltage

- 120 = 120V 230 = 220-240V 277 = 277V

Finish

- B = Black W = White S = Silver

Example Part Number:

LX2038-B09 **10-92** **TW** **P1** - **PT5-ED** **120** **W**
FIXTURE MODEL LED RATING COLOR TEMP OPTIC FITTING/ DIMMING VOLTAGE FINISH

Other Options (Consult Factory):

- Custom Stems, specify length (4" - 48")
- Custom Finish, RAL palette

LX2038 • MOUNTING OPTIONS

FITTING

SIDE VIEW

STEM LENGTH VIEW

**PT5-ED Track Fitting
with Integral Dimmer**

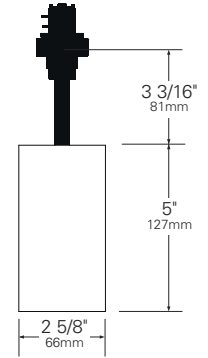
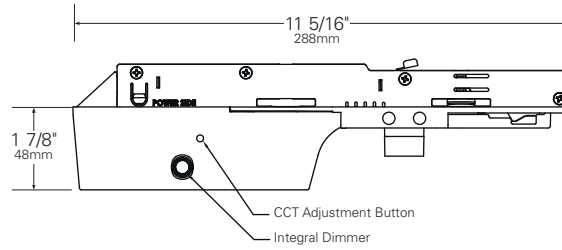

LX2038 • PERFORMANCE

The performance characteristics of the LumeLEX family of products can be customized based on the LED module and the optic (reflector) selected.

Each available LED module is defined by four characteristics – the color rendering index (CRI), the correlated color temperature (CCT), the power that it uses (watts), and its “available lumens.” Note that available lumens is a theoretical value that represents the light output of the module on its own – no fixture or optic attached.

In the LSI part number, the LED module is specified with a range of numbers that immediately follow the product series number. For example, in the part number LX2038-B0910-92TWP1-PT5-ED120B, the “**B0910-92TW**” represents an LED module with an output of 1000 lumens, a CRI of 92, a power usage of 15 watts and a color temperature of 2700K-6500K.

The available optics (reflectors) are characterized by size, beam angle, and in some cases the characteristics of the field angle (narrow or wide).

The optic is specified by the two characters that follow the LED designation in the part number. For example, the “**P1**” in LX2038-B0910-92TWP1-PT5-ED120B is a 50mm diameter optic that has a 16-Degree beam.

Additional parameters, such as Center Beam Candle Power (CBCP), Delivered Lumens, and Efficiency (Lumens per Watt) are all shown in a table that is organized by LED module and optic combination.

CBCP = Center Beam Candle Power			
LED Rating	Optic (Reflector)		
Lumens/CRI/Wattage	P1	P2	P4
1000/92/15	4,827	3,318	2,080

Delivered Lumens			
LED Rating	Optic (Reflector)		
Lumens/CRI/Wattage	P1	P2	P4
1000/92/15	439	524	557

Efficiency = Lumens Per Watt			
LED Rating	Optic (Reflector)		
Lumens/CRI/Wattage	P1	P2	P4
1000/92/15	29	35	37

Absolute range of values are +/- 10% of typical value, and are for all color temperatures

LED Rating Lumens/CRI/Wattage SKU Code	1000/92/15 10-92
Nominal Fixture Power (+/- 20%), Watts	15
Maximum Inrush Current Amps	10
Minimum Power Factor	0.92

Inrush current is instantaneous current drawn by the LED only when fixture is initially powered on or instantaneously changed from full dim to full bright. For more details see Dimming Application Sheet, IS-0119.

LX2038 • OPTICS

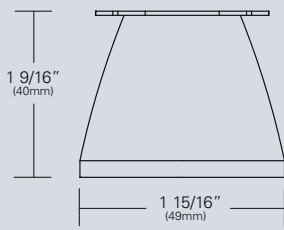

LX-P16-REF-CLR (P1) (50mm/16°)

Faceted specular metal optic.
Tool-less twist and lock
installation. Aluminized finish.

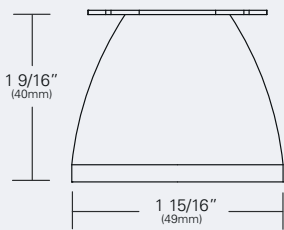

LX-P24-REF-CLR (P2) (50mm/24°)

Faceted specular metal optic.
Tool-less twist and lock
installation. Aluminized finish.

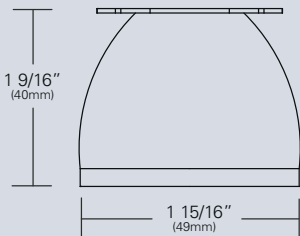

LX-P40-REF-CLR (P4) (50mm/40°)

Faceted specular metal optic.
Tool-less twist and lock
installation. Aluminized finish.

LX2038 • PHOTOMETRIC DATA

LED RATING: 10-92

P1-50mm DIA Optic

Beam Spread (minimum) **16°**
 Center Beam Candlepower **4827**
 CRI **92**

P2-50mm DIA Optic

Beam Spread (minimum) **24°**
 Center Beam Candlepower **3318**
 CRI **92**

P4-50mm DIA Optic

Beam Spread (minimum) **40°**
 Center Beam Candlepower **2080**
 CRI **92**

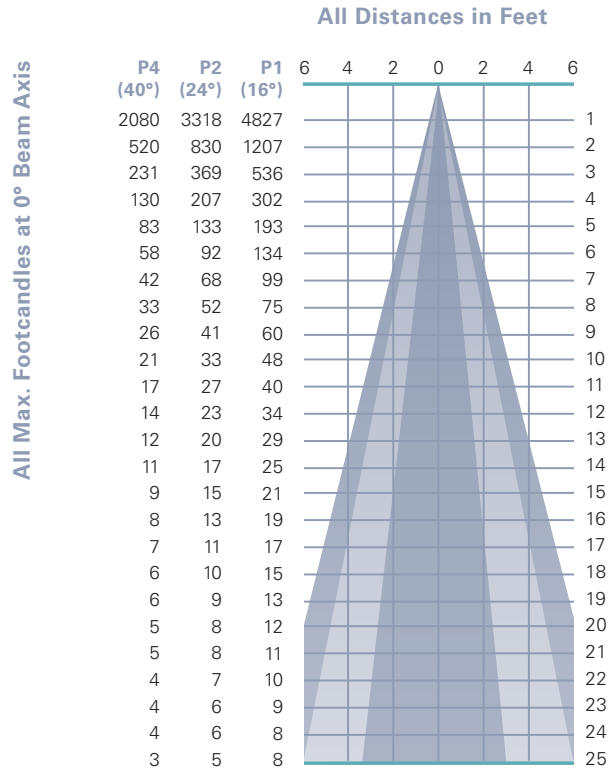

Photometric Data based on LED Rating: 10-92 (1000 Lumens/92CRI/15watts)

LX2038 • ACCESSORIES



1' LIGHT BLOCKING SCREENS AAA

Stainless steel mesh screens used alone or in combinations will block from approximately 20% to 90% of the transmitted light without changing color temperature of the light.

No.	% of Light Blocked
AAA801S	20
AAA802S	30
AAA803S	40



LOUVER HEX AAAB

1/8" thick Hexcell black metal louver used for thin profile. Black finish.



BACKER RING AAAB

Aluminum ring to hold thin film gels when no other size AAA accessories are being used. Black finish.

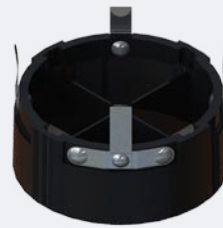

CROSS BAFFLE LX2030B

Controls spill light and glare. Capable of holding up to (2) additional AAA-size accessories. Black finish.

1. Figures vary based upon LED module/optic being used and relationship of screen(s) to LED module/optic and to each other.

LX2038 • GELS

As the foremost innovator in accent lighting, LSI offers a complete range of pre-cut Gels to modify the spread and color of light for the LumeLEX LED Series.



LumeLEX® SPREAD GELS

Size: AAA (60 mm diameter)	Spread Gel
GEL-L1-AAA	1° Spread Gel
GEL-L5-AAA	5° Spread Gel
GEL-L10-AAA	10° Spread Gel
GEL-L20-AAA	20° Spread Gel
GEL-L30-AAA	30° Spread Gel
GEL-L40-AAA	40° Spread Gel
GEL-L60-AAA	60° Spread Gel
GEL-L80-AAA	80° Spread Gel
GEL-L30X5-AAA	30° by 5° Spread Gel
GEL-L40X1-AAA	40° by 1° Spread Gel
GEL-L60X1-AAA	60° by 1° Spread Gel
GEL-L60X10-AAA	60° by 10° Spread Gel
GEL-L75X45-AAA	75° by 45° Spread Gel
GEL-L80X50-AAA	80° by 50° Spread Gel
GEL-R101-AAA	Beam Softener (Light Frost)

LumeLEX® COLOR GELS

Size: AAA (60 mm diameter)	Gel Color	% of Light Transmission	Size: AAA (60 mm diameter)	Gel Color	% of Light Transmission
GEL-R2-AAA	Bastard Amber	78	GEL-R312-AAA	Canary	85
GEL-R7-AAA	Pale Yellow	96	GEL-R331-AAA	Shell Pink	68
GEL-R12-AAA	Straw	88	GEL-R383-AAA	Sapphire Blue	4
GEL-R13-AAA	Straw Tint	78	GEL-R397-AAA	Pale Grey	70
GEL-R14-AAA	Medium Straw	68	GEL-R2001-AAA	Storaro Red	12
GEL-R21-AAA	Golden Amber	43	GEL-R2004-AAA	Storaro Green	15
GEL-R25-AAA	Orange Red	14	GEL-R2009-AAA	Storaro Violet	3
GEL-R26-AAA	Light Red	12	GEL-R3202-AAA	Full Blue CTB	36
GEL-R27-AAA	Medium Red	4	GEL-R3204-AAA	Half Blue CTB	52
GEL-R57-AAA	Lavender	24	GEL-R3206-AAA	Third Blue CTB	64
GEL-R62-AAA	Booster Blue	54	GEL-R3216-AAA	Eighth Blue CTB (Boosts 3200K to 3300K)	81
GEL-R71-AAA	Sea Blue	30	GEL-R3318-AAA	Tough 1/8 Minusgreen	89
GEL-R72-AAA	Azure Blue	44	GEL-R3410-AAA	Roscosun (1/8 CTO) (Reduces 5500K to 4900K)	92
GEL-R91-AAA	Primary Green	7	GEL-R3441-AAA	Full Straw (CTS)	50
GEL-R97-AAA	Light Grey	50	GEL-R3443-AAA	Quarter Straw (1/4 CTS)	81
GEL-R98-AAA	Medium Grey	25	GEL-R4330-AAA	CalColor 30 Cyan	63
GEL-R101-AAA	Light Frost	N/A	GEL-R4415-AAA	CalColor 15 Green	67
GEL-R104-AAA	Tough Silk	N/A	GEL-R4490-AAA	CalColor 90 Green	25
GEL-R119-AAA	Lt. Hamburg Frost	N/A	GEL-R4860-AAA	CalColor 60 Pink	46
GEL-R121-AAA	Blue Diffusion	N/A	GEL-R4890-AAA	CalColor 90 Pink	38
GEL-R305-AAA	Rose Gold	75	GEL-R4930-AAA	CalColor 30 Lavender	47

* Backer Ring AAAB required to hold gels when no other rimmed "AAA" accessories are used.

Type	ROSCO #	ROSCO Description	Resulting CCT
Amber Filters Lower CCT	3420	Roscosun Double CTO	1531
	3407	Roscosun CTO	1999
	3401	Roscosun 85	2154
	3411	Roscosun 3/4 CTO	2154
	3408	Roscosun 1/2 CTO	2414
	3409	Roscosun 1/4 CTO	2664
	3410	Roscosun 1/8 CTO	2830
	3114	UV Filter	2930
Blue Filters Raise CCT	3220	Double Blue CTB	N/A
	3202	Full Blue CTB	4942
	3203	Three-Quarter Blue CTB	4286
	3204	Half Blue CTB	3769
	3206	Third Blue CTB	3517
	3208	Quarter Blue CTB	3297
	3216	Eighth Blue CTB	3112

COLOR MEDIA

COLOR FILTERS

As the foremost innovator in accent lighting, LSI offers a complete range of permanent fade-free glass color filters, which are available in four stock diameters. All glass color filters are rimmed in a seamless aluminum ring and are slotted for heat expansion.



Size	Diameter	LSI Fixture Series	No.	Color	% of Light Transmission
AAA	2 3/8"	LumeLEX® 2020/2030/2031/2038, SSLCX16, SSL260	902	Medium Pink	36
			903	Deep Pink	37
AA	3"	LumeLEX® 2044, LumeLEX 2048	904	Flesh Pink	73
			906	Pale Lavender	14
A	3 1/2"	LumeLEX® 2060, SSL230, SSLCX30, SSLGR30CL	907	Surprise Pink	19
			908	Lilac	21
C	4 3/4"	LumeLEX® 2084, LumeLEX® 2088, SSL238, SSLCX36, SSLCX38, SSLGR38CL	910	Warm Red	10
			911	Strawberry	6
			912	Ruby	4
			913	Magenta	1
			914	Light Amethyst	25
			915	Medium Amethyst	16
			916	Deep Amethyst	4
			917	Olive	18
			918	Light Green	68
			920	Medium Green	25
			921	Deep Green	7
			922	Silver green	65
			923	Yellow Green	49
			924	Emerald Green	12
			925	Light Turquoise	68
			926	Medium Turquoise	40
			927	Deep Turquoise	17
			928	Light Blue	34
			930	Medium Blue	3
			932	Daylight	59
			933	Gene Moore Blue	18
			936	Grey	56
			937	Light Blue Green	17
			939	Light Amber	68
			940	Medium Amber	48
			941	Deep Amber	43
			942	Straw	78
			943	Gold	87
			944	Canary Yellow	84
			945	Lemon	81
			946	Pumpkin	32
			947	Tangerine	20
			948	Orange	23
			949	Pink Gold	54
			950	Bronze	48
			951	Brass	11
			952	Autumn Tan	11
			953	Leaf Brown	19
			954	Butter Pecan	3
			955	Toasted Almond	1

Notes:

1. Values given are approximate due to slight variations in glass color and thickness.

COLOR MEDIA

DICHROIC COLOR FILTERS

In addition to our complete line of glass color filters, LSI now offers dichroic glass color filters that achieve purer, more saturated, richer color by selective wavelength transmission. Since these filters reflect rather than absorb the unwanted color wavelengths, a higher intensity of colored light can be obtained with fewer or lower wattage fixtures. In addition, this selective transmission allows for very accurate color matching from filter to filter.

All standard LSI filter sizes are available in a wide palette of well chosen dichroic colors that can be used with all LSI fixtures that accept accessories.

LSI dichroic glass color filters have the added benefit of being rimmed for extra durability to allow for frequent usage without fear of breakage or edge chipping.

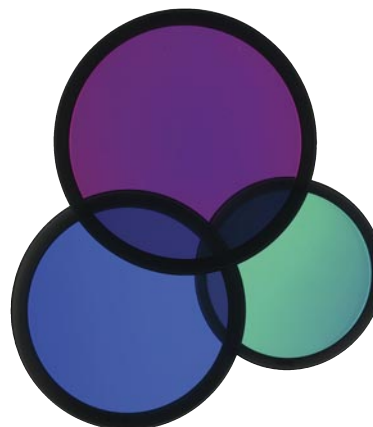

Size	Diameter	LSI Fixture Series	Technical Data	No.	Color	% of Light Transmission
AAA	2 3/8"	LumeLEX® 2020/2030/2031/2038, SSLCX16, SSL260	Dichroic color filters are created in a vacuum chamber by multi-layer vapor deposits of different minerals onto low expansion, chemically resistant Borosilicate glass.	2001	Light Pink	69
AA	3"	LumeLEX® 2044, LumeLEX 2048	Deposits are made in alternating layers of varying microscopic thickness which allow very narrow color wavelengths to be selectively transmitted and all other wavelengths to be reflected.	2002	Medium Pink	43
A	3 1/2"	LumeLEX® 2060, SSL230, SSLCX30, SSLGR30CL	LSI does not recommend using dichroic color filters with lamps or fixtures that have beam spreads greater than 40° because a secondary color aura is created by the wide angular transmitted wavelengths that are different than the desired color wavelength.	2003	Hot Pink	11
C	4 3/4"	LumeLEX® 2084, LumeLEX® 2088, SSL238, SSLCX36, SSLCX38, SSLGR38CL	Since there is mainly transmission and reflection of the color wavelengths by the dichroic filter and very little absorption, the dichroic filter can be used with many high temperature lights that normally would not accept color filters.	2004	Pale Pink	55
				2010	Deep Magenta	29
				2011	Lavender	24
				2012	Vivid Magenta	31
				2013	Lavender Accent	48
				2014	Lilac	37
				2015	Purple Fusion	12
				2020	Sky Blue	39
				2021	Sea Blue	39
				2022	Cyan	33
				2023	Light Blue Green	30
				2024	Primary Blue	24
				2025	Medium Red Blue	15
				2026	Deep Purple	16
				2027	Peacock Blue	53
				2028	Mediterranean Blue	20
				2029	Boost Blue	51
				2040	Light Yellow Green	64
				2041	Fern Green	47
				2042	Turquoise	35
				2043	Primary Green	31
				2044	Industrial Green	64
				2050	Yellow	80
				2051	Amber	71
				2052	Amber Blush	38
				2053	Bastard Amber	71
				2054	Goldenrod	63
				2055	Bright Straw	56
				2060	Medium Orange	51
				2061	Orange	44
				2070	Flame Red	27
				2071	Primary Red	25