

SPOTLIGHT SERIES INSTALLATION AND OPERATION INSTRUCTIONS

Applies to 230, 231, 236, 260, 261, 238, 239, 270, 280, 290 series fixtures, including SSL models.

WARNING: TO REDUCE THE RISK OF ELECTRICAL SHOCK, DISCONNECT POWER BEFORE INSTALLATION OR MAINTENANCE. TO REDUCE RISK OF FIRE, KEEP AWAY FROM COMBUSTIBLE MATERIALS. THIS PRODUCT MUST BE INSTALLED IN ACCORDANCE WITH THE APPLICABLE CODE BY A PERSON FAMILIAR WITH THE CONSTRUCTION AND OPERATION OF THE PRODUCT AND THE HAZARDS INVOLVED.

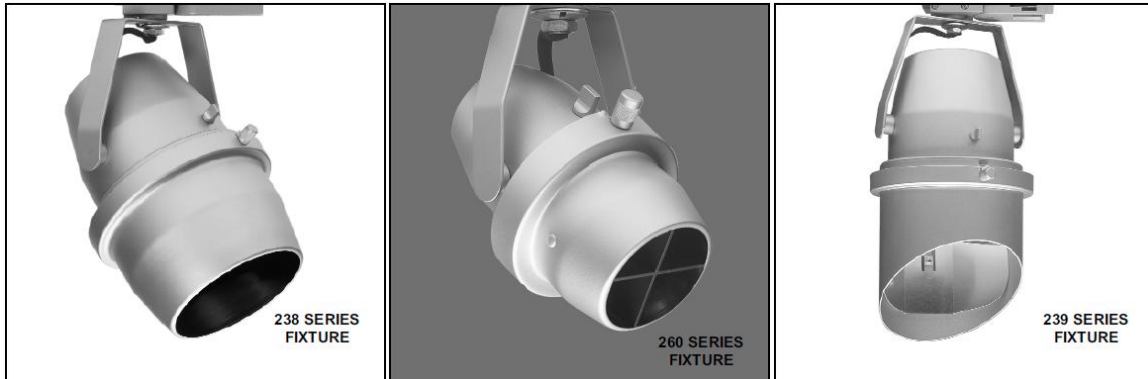

Installation & Removal of LSI Fixture with -00 Adapter

1. To insert into track, turn switch **OFF** and open *Handle*. Insert *Adapter* straight up into the track until it seats evenly, close *Handle*, turn switch **ON**.
2. If using one circuit track, make sure that the *Brass Contacts* which protrude from the side of the *Adapter* are inserted facing the copper busbars inside the track.
3. If using two circuit track, inserting the *Adapter* in one direction will connect to *Circuit ONE*. Removing and reversing the direction of the *Adapter* will connect to *Circuit TWO*.
4. To remove the *Adapter*, turn switch **OFF**, open handle and pull straight away from track.

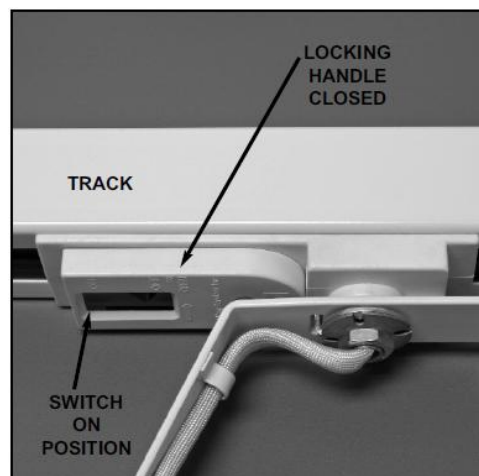
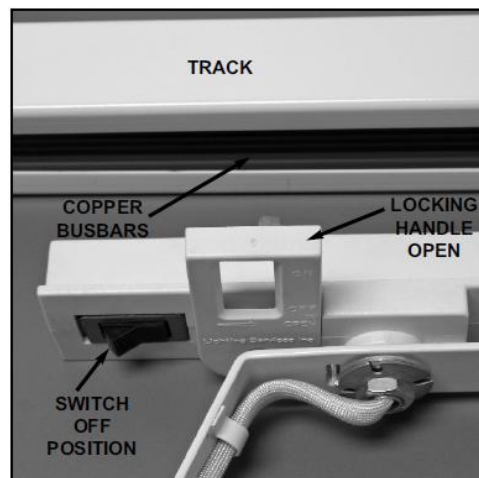

Installation of Fixture with -2G Universal Flange Adapter

1. Turn off all power to wires for fixture.
2. The fixture with *-2G Adapter* can be mounted directly to any non-combustible material via the 2-hole flanged steel *Mounting Plate* for any screw / bolt-up application. Please check code requirements for fixture mounting and check Distance-From-Wall-Label inside fixture.
3. Attach *Cord* or *Plug* of *-2G Adapter* to power source.
4. Turn switch, located on base of *Adapter*, **ON**.

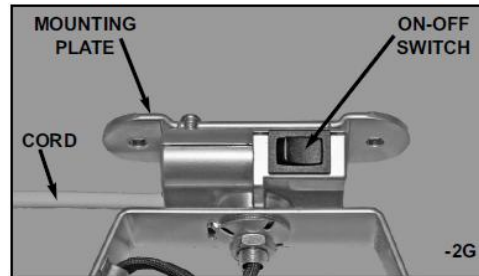

Installation of Fixture With -3G C-Clamp Adapter

1. Turn off all power to wires for fixture.
2. The fixture with *-3G Adapter* can be mounted to any non-combustible pipe measuring from 5/8" to 2" outside diameter. Please check code requirements for fixture mounting and check Distance-From-Wall-Label inside fixture.
3. Turn *C-Clamp Knob* clockwise to tighten clamp.
4. Attach *Cord* or *Plug* of *-3G Adapter* to power source.
5. Turn switch, located on base of *Adapter*, **ON**.



Installation of Fixture With -5 or -5A Canopy

1. Turn off all power to wires for fixture.
2. The fixture with *-5 or -5A Canopy* can be mounted directly to a ceiling constructed of non-combustible material. Please check code requirements for fixture mounting and check Distance-From-Wall-Label inside fixture.
3. Remove *Crossbar* from *Canopy* by unscrewing the two (2) *Canopy Mounting Screws*.
4. Attach *Crossbar* to Junction Box in ceiling with screws.(by others)
5. Connect power feed wires from Junction Box to *Fixture Wires*.
6. Once connections have been completed, attach *Canopy* to ceiling with two (2) *Canopy Mounting Screws* supplied.

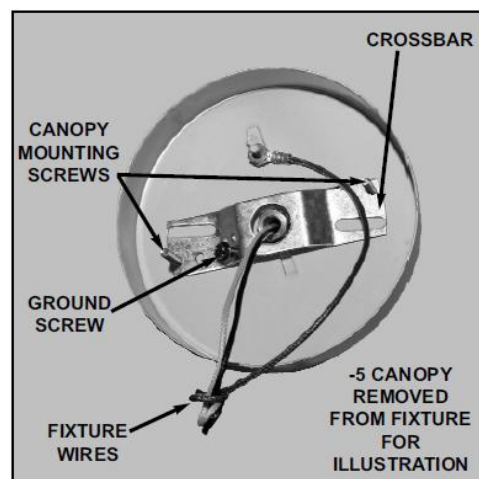

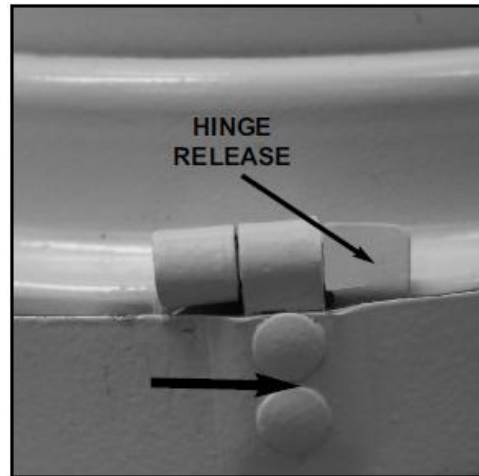

Changing Fronts

To change a spotlight to wallwash front & vice versa:

1. Turn fixture switch **OFF**. Let fixture cool.
2. Open the fixture via the *Relamping Knob*.
3. While pressing the hinge release, slide the front to the right as arrow indicates.
4. To attach the other front, slide the male hinge into the female hinge until *Hinge Release* snaps into place.
5. Close the front.
6. Turn *Relamping Knob* clockwise until snug.
7. Turn fixture switch **ON**.

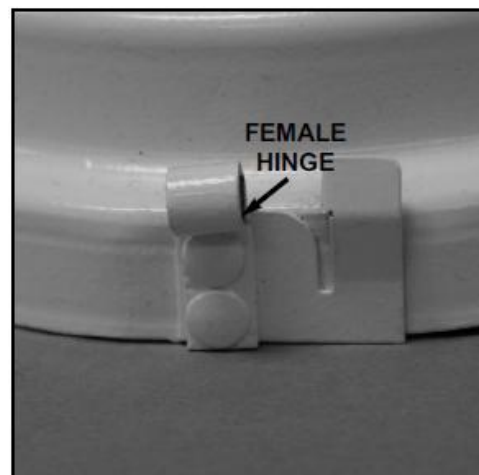
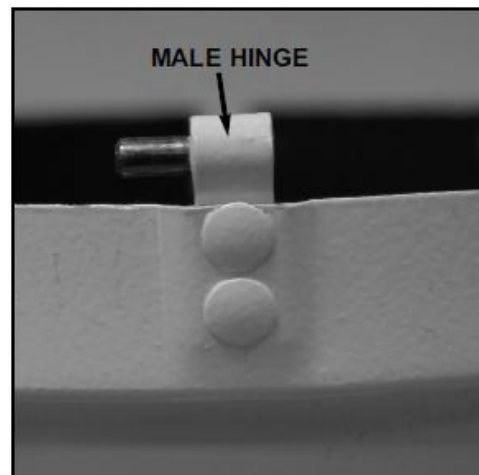

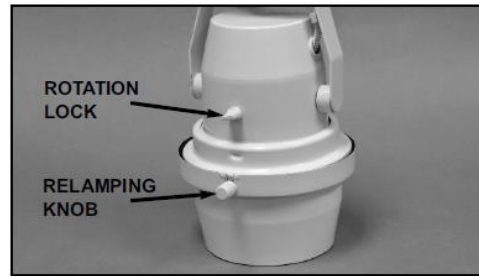

Relamping

1. Turn fixture switch **OFF**. Let fixture cool.
2. The front of the fixture must be opened to relamp.
3. Turn *Relamping Knob* counter clockwise until you are able to swing out the front of the fixture.
4. Remove old lamp, turn lamp counter clockwise. Read Lamp-Info-Label inside fixture.
5. Insert new lamp (see fixture label for specific lamp type and wattage) into Snap-in *Lamp Holder* or *socket*. Ensure that it is properly engaged.
6. Close front and turn *Relamping Knob* clockwise until snug.
7. Turn fixture switch **ON**.

LAMP TYPES:

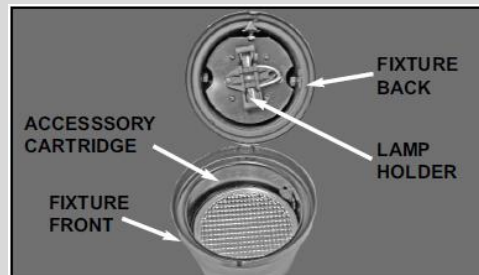

PAR36 / AR111 LAMPS

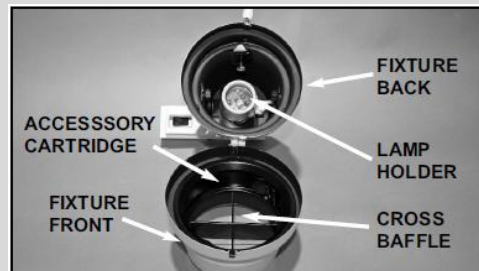

SCREW BASE LAMPS

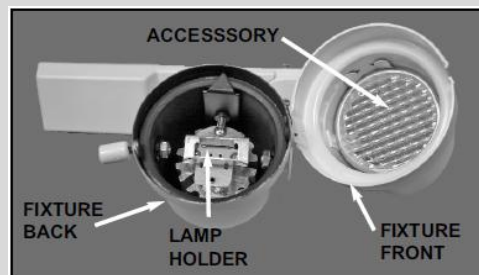

MR16 LAMPS

To install and remove *Accessories* in models with an *Accessory Cartridge*:

1. Turn fixture switch **OFF**. Let fixture cool.
2. Open the fixture via the *Relamping Knob*.
3. You can insert any appropriately sized *Accessory* into the *Cartridge* without removing the *Cartridge*.
4. You can also remove the entire *Cartridge* by pulling the *Cartridge* straight out. Install up to three *Accessories*.
5. Reinsert the *Accessory Cartridge* back into the front of the fixture and close fixture.
6. Turn *Relamping Knob* clockwise until snug.
7. Turn fixture switch **ON**.

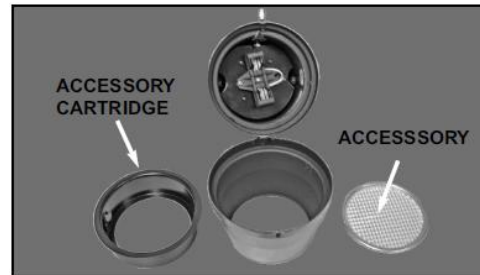

To install and remove *Accessories* in models with *Internal Accessory Clips*:

1. Turn fixture switch **OFF**. Let fixture cool.
2. Open the fixture via the *Relamping Knob*.
3. You can insert any correctly sized *Accessory* into the front, via internal spring clips. Install up to three *Accessories*.
4. Close front and turn *Relamping Knob* clockwise until snug.
5. Turn fixture switch **ON**.

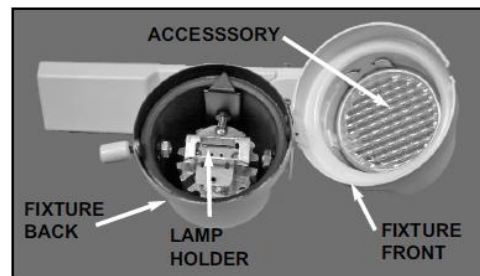

To install and remove *Accessories* in models with *External Accessory Clips*:

1. Turn fixture switch **OFF**. Let fixture cool.
2. You can insert any correctly sized *Accessory* into the front, via external spring clips. Install up to three *Accessories*.
3. Turn fixture switch **ON**.