

LX2030 • 120/277V • LUMENETIX-ARAYA • 19MM



Shown with optional
Cross Baffle accessory

These LED Cylinder units offer high functionality in LSI's smallest, sleekest package.

- Designed for the Lumenetix-araya Color Tuning LED 19mm module up to 13 Watts
- Extremely tight color consistency (less than 2 MacAdam Ellipses, ± 0.002 DUV)
- System efficiency up to 27 lumens/watt
- On board closed loop feedback compensates each channel for thermal and optical depreciation
- 50,000 hour life to 70% lumen output, L70 at 95°F max ambient
- Tunable white from 1650K to 8000K
- Full color tuning of saturated colors and pastels
- Color Rendering Index (CRI) of 90+ from 2000K to 6000K
- 750 produced lumens
- Tested to LM79 and LM80 Protocols
- Choice of dimming down to <1%. Compatible with 2 zones for 0-10V
- 0-10V with the ability to control intensity and CCT simultaneously and individually
- Compatible with DMX, RDM, and Bluetooth via IOS app
- Uses the following four DMX channels: Dimming, CCT, Saturation, and Hue
- Field interchangeable optics (15° or 40°) modify the beam spread distribution
- Accessory holder accepts up to two size-AAA LSI filters and accessories
- Finishes: LSI Black, White, and Silver
- Fixture weight: 2 lbs
- All modules are field replaceable

FIXTURE PART NUMBERS

Please review the **ORDERING INFORMATION** section on the next page as well as the **MOUNTING OPTIONS** on page 3 to create a part number for each fixture that specifies the following:

- LED Module
- LED Rating
- Color Temperature
- Optic - mm/beam spread
- Fitting/Controls (Dimming)
- Voltage
- Finish

PART NUMBER

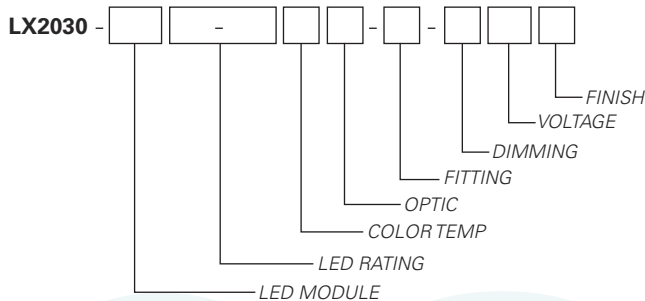

Example Part Number: **LX2030-L1908-90COE0-CT2-DX120W** is a fixture with a Lumenetix-araya 19mm module, 750 Lumen/90 CRI/13 watt LED Rating, Full Color and Dynamic White Color Temperature, 7° Optic, CT2 CONTROLTrack fitting with DMX Address knobs and DMX compatible control gear, 120V and a White finish.

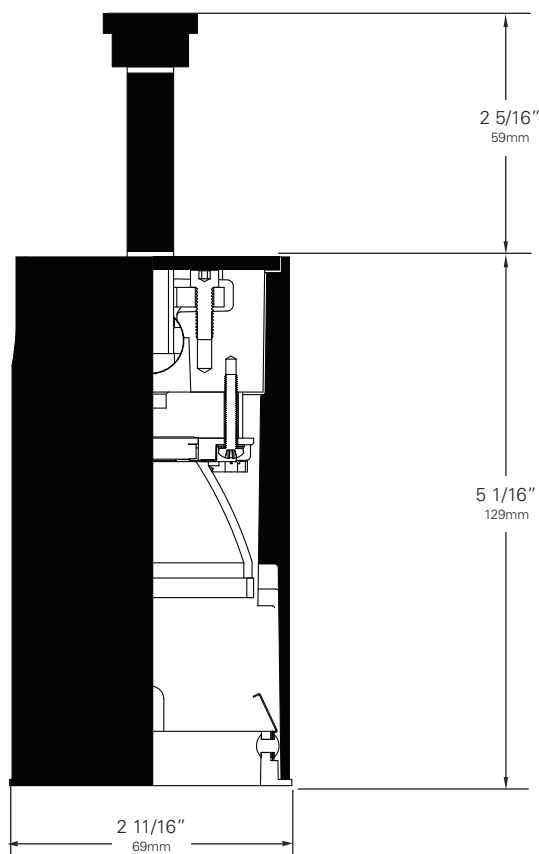
LX2030 • 120/277V • LUMENETIX-ARAYA • 19MM**Color Temperature & Center Point Tolerance**

Color Temp	Center Point	Tolerance
2700K	2700K	+/- 40K
3000K	2950K	+/- 50K
3500K	3420K	+/- 60K
4000K	4000K	+/- 70K

Chromaticity Specifications

LED	R _a -CRI	R _f -Fidelity	R _g -Gamut Area
T19-TS9 - 83	83	78	101
T19-TS9 - 98	98	96	103

ORDERING INFORMATION**Base Fixture Model**

LX2030-L19

LED Rating (Lumens/CRI/Wattage)

08-90 = 750/90/13

Color Temperature

DW= Dynamic White 1650-8000K*

CO= Full Color and Dynamic White 1650-8000K
(DMX Dimming only)

Optic

S1 = 50mm/15°

S4 = 50mm/40°

Fitting/Controls (Dimming)

CT2-10 = CONTROLTrack Fitting & 0-10V (1%)*

CT2-DX = CONTROLTrack Fitting & DMX (<1%)

PT2-BT = POWERTrack Fitting & Bluetooth-IOS App (1%)

5A-10 = Canopy Fitting & 0-10V (1%)*

5A-DX = Canopy Fitting & DMX (<1%)

5A-BT = Canopy Fitting & Bluetooth IOS App (1%)

Voltage

120 = 120V 230 = 220-240V

Finish

B = Black W = White S = Silver

Example Part Number:

LX2030-L19 **08-90** **CO** **S4 - CT2-DX** **120** **W**
FIXTURE MODEL LED RATING COLOR TEMP OPTIC FITTING/DIMMING VOLTAGE FINISH

Other Options (Consult Factory):

- Custom Stems, specify length (4" - 48")
- Custom color, RAL palette

*0-10V available in Dynamic White only.

LX2030 • MOUNTING OPTIONS

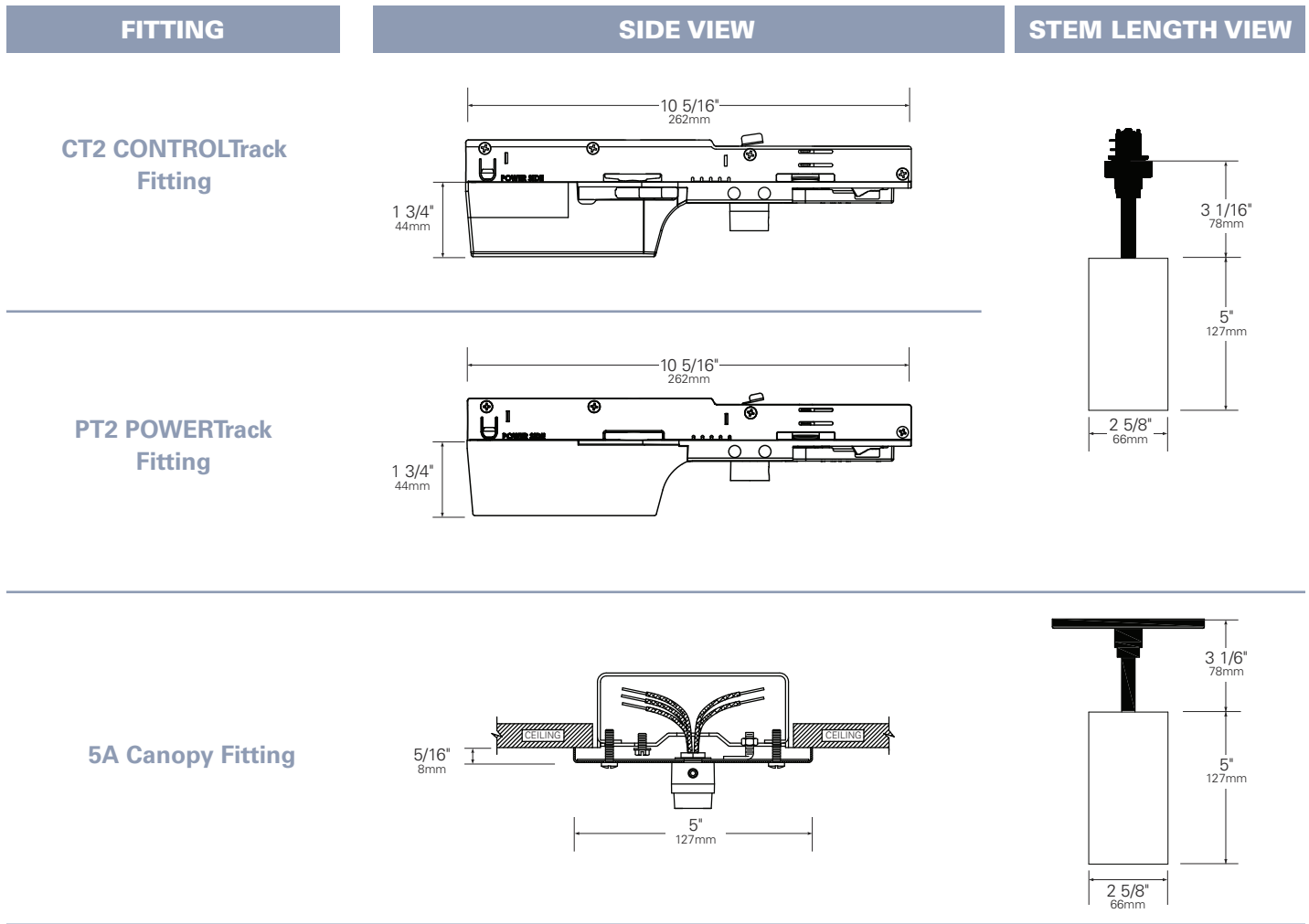

LX2030 • PERFORMANCE

The performance characteristics of the LumeLEX family of products can be customized based on the LED module and the optic (reflector) selected.

Each available LED module is defined by four characteristics – the color rendering index (CRI), the correlated color temperature (CCT), the power that it uses (watts), and its “available lumens.” Note that available lumens is a theoretical value that represents the light output of the module on its own – no fixture or optic attached.

In the LSI part number, the LED module is specified with a range of numbers that immediately follow the product series number. For example, in the part number LX2030-L1908-90COS4-CT2-DX120W, the “**L1908-90CO**” represents a 19mm Lumenetix-araya module with an output of 750 lumens, a CRI of 90, a power usage of 13 watts and dynamic white color tuning.

The available optics (reflectors) are characterized by size, beam angle, and in some cases the characteristics of the field angle (narrow or wide). The optic is specified by the two characters that follow the LED designation in the part number. For example, the “**S4**” in LX2030-L1908-90COS4-CT2-DX120W is a 50mm diameter optic that has a 40-Degree beam.

Additional parameters, such as Center Beam Candle Power (CBCP), Delivered Lumens, and Efficiency (Lumens per Watt) are all shown in a table that is organized by LED module and optic combination.

CBCP = Center Beam Candle Power		
LED Rating	Optic (Reflector)	
Lumens/CRI/Wattage	S1	S4
750/90/13	2,153	1,208

Delivered Lumens		
LED Rating	Optic (Reflector)	
Lumens/CRI/Wattage	S1	S4
750/90/13	233	353

Efficacy = Lumens Per Watt		
LED Rating	Optic (Reflector)	
Lumens/CRI/Wattage	S1	S4
750/90/13	18	27

Absolute range of values are +/- 10% of typical value, and are for all color temperatures

LED Rating Lumens/CRI/Wattage SKU Code	750/90/13 08-90
Nominal Fixture Power (+/- 20%), Watts	13
Maximum Inrush Current, Amps	10
Minimum Power Factor	0.90

Inrush current is instantaneous current drawn by the LED only when fixture is initially powered on or instantaneously changed from full dim to full bright. For more details see Dimming Application Sheet, IS-0119.

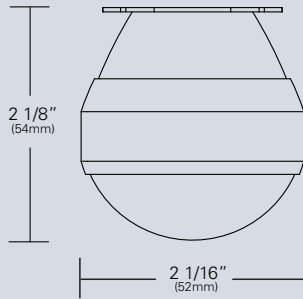
LX2030 • OPTICS**LX-S15-REF-B (S1)**
(50mm/15°)

Anti-reflective coated aspheric lens. Tool-less, twist and lock installation. Black Finish.

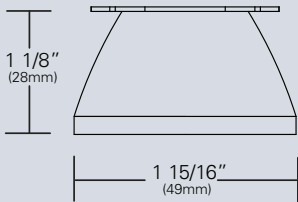
**LX-S50-REF-CLR (S4)**
(50mm/40°)

Computer designed polycarbonate specular optic. Tool-less, twist and lock installation. Aluminized Finish.

LX2030 • PHOTOMETRIC DATA

LED RATING: 08-90

S1-50mm DIA Optic

Beam Spread (minimum) **15°**
 Center Beam Candlepower **2153**
 CRI **90**

S4-50mm DIA Optic

Beam Spread (minimum) **40°**
 Center Beam Candlepower **1208**
 CRI **90**

All Max. Footcandles at 0° Beam Axis

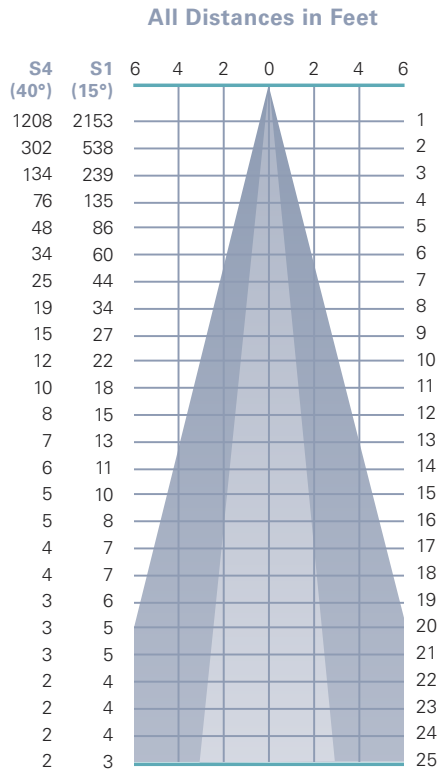

Photometric Data based on LED Rating: 08-90 (750 Lumens/90CRI/13watts)

LX2030 • ACCESSORIES

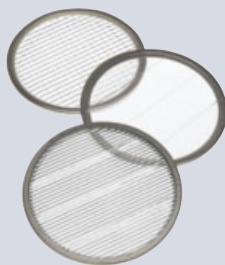

SPREAD LENSES AND BEAM SOFTENER

No.	Description	% of Light Transmission
AAA990	Spread Lens/Clear	83 (5°X 50°)
AAA992	Spread Lens/Clear	85 (5°X 30°)
AAA995	Spread Lens/Clear	83 (50°X 50°)
AAA996	Spread Lens/Clear	86 (45°X 50°)
AAA998	Beam Softener/Clear	80 (45°X 45°)

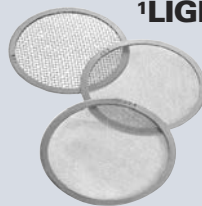

¹LIGHT BLOCKING SCREENS AAA

Stainless steel mesh screens used alone or in combinations will block from approximately 20% to 90% of the transmitted light without changing color temperature of the light.

No.	% of Light Blocked
AAA801S	20
AAA802S	30
AAA803S	40



LOUVER HEX AAA

1/8" thick Hexcell black metal louver used for thin profile. Black finish.



LX2031FR WALL WASH CYLINDER HOUSING

which includes slash front, accessory cartridge, spread gel (75° x 45°) and kicker reflector (for use with 40° optic only).

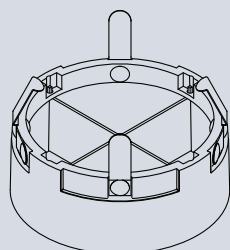

CROSS BAFFLE LX2030

Controls spill light and glare. Capable of holding up to (2) additional AAA-size accessories. Black finish.

1. Figures vary based upon LED module/optic being used and relationship of screen(s) to LED module/optic and to each other.

COLOR MEDIA

COLOR FILTERS

As the foremost innovator in accent lighting, LSI offers a complete range of permanent fade-free glass color filters, which are available in nine stock diameters. All glass color filters are rimmed in a seamless aluminum ring and are slotted for heat expansion.

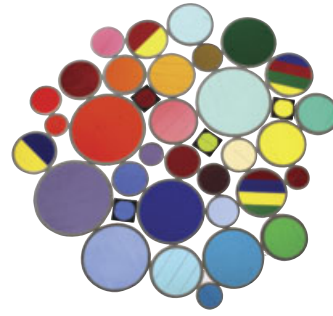

Size	Diameter	LSI Fixture Series	No.	Color	% of Light Transmission
AAA	2 3/8"	LumeLEX® 2020/2030/2031/2038, SSLCX16, SSL260, LumeLEX MAR-S	902	Medium Pink	36
			903	Deep Pink	37
			904	Flesh Pink	73
ZM	2 13/16"	LZ ZOOM	906	Pale Lavender	14
			907	Surprise Pink	19
AA	3"	LumeLEX® 2044, LumeLEX 2048	908	Lilac	21
			910	Warm Red	10
A	3 1/2"	LumeLEX® 2060, SSL230, SSLCX30, SSLGR30CL	911	Strawberry	6
			912	Ruby	4
B	4 1/4"	LumeLEX® MAR-L	913	Magenta	1
			914	Light Amethyst	25
			915	Medium Amethyst	16
C	4 3/4"	LumeLEX® 2084, LumeLEX® 2088, SSL238, SSLCX36, SSLCX38, SSLGR38CL	916	Deep Amethyst	4
			917	Olive	18
			918	Light Green	68
			920	Medium Green	25
			921	Deep Green	7
			922	Silver green	65
			923	Yellow Green	49
			924	Emerald Green	12
			925	Light Turquoise	68
			926	Medium Turquoise	40
			927	Deep Turquoise	17
			928	Light Blue	34
			930	Medium Blue	3
			932	Daylight	59
			933	Gene Moore Blue	18
			936	Grey	56
			937	Light Blue Green	17
			939	Light Amber	68
			940	Medium Amber	48
			941	Deep Amber	43
			942	Straw	78
			943	Gold	87
			944	Canary Yellow	84
			945	Lemon	81
			946	Pumpkin	32
			947	Tangerine	20
			948	Orange	23
			949	Pink Gold	54
			950	Bronze	48
			951	Brass	11
			952	Autumn Tan	11
			953	Leaf Brown	19
			954	Butter Pecan	3
			955	Toasted Almond	1

Notes:

1. Values given are approximate due to slight variations in glass color and thickness.

COLOR MEDIA

DICHROIC COLOR FILTERS

In addition to our complete line of glass color filters, LSI now offers dichroic glass color filters that achieve purer, more saturated, richer color by selective wavelength transmission. Since these filters reflect rather than absorb the unwanted color wavelengths, a higher intensity of colored light can be obtained with fewer or lower wattage fixtures. In addition, this selective transmission allows for very accurate color matching from filter to filter.

All standard LSI filter sizes are available in a wide palette of well chosen dichroic colors that can be used with all LSI fixtures that accept accessories.

LSI dichroic glass color filters have the added benefit of being rimmed for extra durability to allow for frequent usage without fear of breakage or edge chipping.

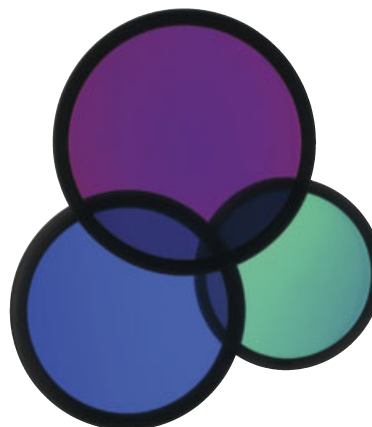

Size	Diameter	LSI Fixture Series	Technical Data	No.	Color	% of Light Transmission
AAA	2 3/8"	LumeLEX® 2020/2030/2031/2038, SSLCX16, SSL260, LumeLEX MAR-S	Dichroic color filters are created in a vacuum chamber by multi-layer vapor deposits of different minerals onto low expansion, chemically resistant Borosilicate glass.	2001	Light Pink	69
ZM	2 13/16"	LZ ZOOM	Deposits are made in alternating layers of varying microscopic thickness which allow very narrow color wavelengths to be selectively transmitted and all other wavelengths to be reflected.	2002	Medium Pink	43
AA	3"	LumeLEX® 2044, LumeLEX 2048	LSI does not recommend using dichroic color filters with lamps or fixtures that have beam spreads greater than 40° because a secondary color aura is created by the wide angular transmitted wavelengths that are different than the desired color wavelength.	2003	Hot Pink	11
A	3 1/2"	LumeLEX® 2060, SSL230, SSLCX30, SSLGR30CL	Since there is mainly transmission and reflection of the color wavelengths by the dichroic filter and very little absorption, the dichroic filter can be used with many high temperature lights that normally would not accept color filters.	2004	Pale Pink	55
B	4 1/4"	LumeLEX® MAR-L		2010	Deep Magenta	29
C	4 3/4"	LumeLEX® 2084, LumeLEX® 2088, SSL238, SSLCX36, SSLCX38, SSLGR38CL		2011	Lavender	24
				2012	Vivid Magenta	31
				2013	Lavender Accent	48
				2014	Lilac	37
				2015	Purple Fusion	12
				2020	Sky Blue	39
				2021	Sea Blue	39
				2022	Cyan	33
				2023	Light Blue Green	30
				2024	Primary Blue	24
				2025	Medium Red Blue	15
				2026	Deep Purple	16
				2027	Peacock Blue	53
				2028	Mediterranean Blue	20
				2029	Boost Blue	51
				2040	Light Yellow Green	64
				2041	Fern Green	47
				2042	Turquoise	35
				2043	Primary Green	31
				2044	Industrial Green	64
				2050	Yellow	80
				2051	Amber	71
				2052	Amber Blush	38
				2053	Bastard Amber	71
				2054	Goldenrod	63
				2055	Bright Straw	56
				2060	Medium Orange	51
				2061	Orange	44
				2070	Flame Red	27
				2071	Primary Red	25