

MAR-S2 • 120/277V • LED • XICATO



The LumeLEX MAR2 Series features the highly efficient Xicato XTM Modules and a variety of optics and accessory options for unprecedented flexibility.

- Designed for the Xicato™ XTM LED module up to 20 Watts
- Extremely tight color consistency (less than 2 MacAdam Ellipses)
- System efficiency up to 100 lumens/watt
- Backed by Xicato's Five Year Color Consistency and Lumen Maintenance Warranty
- Tested to LM79 and LM80 Protocols
- 50,000 hour life to 70% lumen output, L₇₀ at 95°F max ambient
- Integral electronic driver compatible with reverse phase (ELV compatible) dimmers down to 5%
- Choice of 40° or 60° field changeable optic
- 25° Aiming
- Choice of LED modules with various lumen outputs
- Choice of color temperatures
- Color Rendering Index (CRI) of either 98 (high) or 83+ (standard)
- No UV or IR emissions; no mercury or lead
- All LumeLEX modules are field replaceable
- Can be ordered for 120V or 277V
- Sturdy steel housing with spun aluminum lamp holders
- Accepts up to three size-AAA LSI filters and accessories
- Thermally protected and approved for all Non-IC ceiling types, including air handling plenums
- Unique spring-loaded clamping system facilitates installation in plaster, sheetrock or acoustic tiles
- Supplied with LED driver
- Flange finishes: LSI Black, White and Silver
- Fixture weight: 10 LB
- 

SPECIFICATIONS

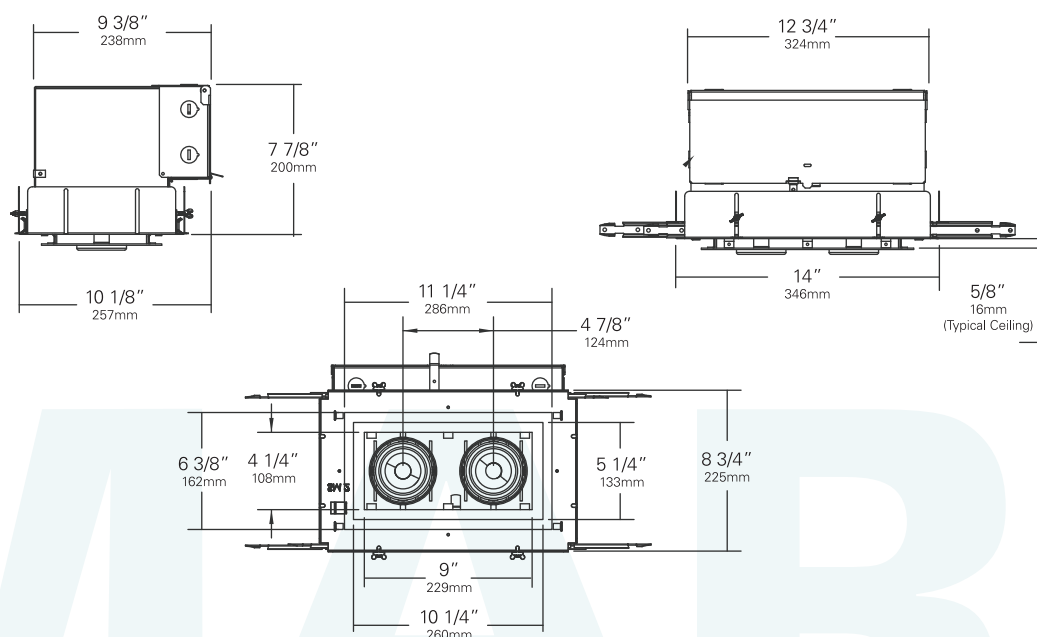

MAR-S2 • 120/277V • LED • XICATO**ORDERING INFORMATION**

1. Choose the product code
(S2) for Small 2-head fixture
2. Choose the numeric code to designate the desired LED Rating
Lumens/CRI/Wattage
(07-98) for 700/98/9
(10-83) for 1000/83/10
(10-98) for 1000/98/12
(15-83) for 1500/83/14
3. Choose the numeric code to designate the desired
Color Temperature
(27) for 2700K **(30)** for 3000K
(35) for 3500K **(40)** for 4000K
4. Use the following alpha-numeric codes to designate the **Optic:**
(M40) for 40° **(M60)** for 60°
5. Choose the letter code for **Dimming Type:**
(TE) Trailing Edge (ELV Reverse Phase) (5%)
(10) 0-10V (10%)
(L3) Lutron Ecosystem
6. Choose the desired **Voltage:**
(120) for 120V **(277)** for 277V
7. Choose a **Finish** for your fixture:
Black **(B)** White **(W)** Silver **(S)** Trimless **(T)**

Example:

LX**MAR-S2** - **10-83** - **27** - **M40** - **TE** - **120** - **W**

FIXTURE LED RATING COLOR TEMP OPTIC DIMMING VOLTAGE FINISH

8. Don't forget your Accessories!

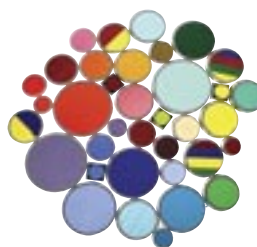
ACCESSORIES**Glass Color Filters AAA**

Selection of 95 permanent rimmed dichroic and rimmed and slotted standard colors.

- **Color and Spread Gels AAA**
- **Backer Ring AAA**

Other accessories:

- **Spread Lenses AAA990, AAA992, AAA995, AAA996**
- **Beam Softener AAA998**
- **Louver Hex AAA**
- **Light Blocking Screens AAA801S, AAA802S, AAA803S**

MAR-S2 • PERFORMANCE

The performance characteristics of the LumeLEX MAR Series can be customized based on the LED module and the optic (reflector) selected.

Each available LED module is defined by four characteristics – the color rendering index (CRI), the correlated color temperature (CCT), the power that it uses (watts), and its “available lumens.” Note that available lumens is a theoretical value that represents the light output of the module on its own – no fixture or optic attached.

In the LSI part number, the LED module is specified with a number that immediately follows the product series number.

For example, in the part number LXMAR-S2-10-83-27-M40-TE-120-W, the “10-83-27” represents an LED module with an output of 1000 lumens, a CRI of 83, a power usage of 12 watts and a color temperature of 2700K.

Additional parameters, such as Center Beam Candle Power (CBCP), Delivered Lumens, and Efficiency (Lumens per Watt) are all shown in a table that is organized by LED module and optic combination.

CBCP = Center Beam Candle Power		
LED Module	Optic (Reflector)	
Lumens/CRI/Wattage	M40	M60
700/98/12	1050	700
1000/83/12	1500	1000
1000/98/17	1500	1000
1500/83/15	2000	1400

Delivered Lumens		
LED Module	Optic (Reflector)	
Lumens/CRI/Wattage	M40	M60
700/98/12	402	668
1000/83/12	602	864
1000/98/17	602	864
1500/83/15	783	1123

Efficiency = Lumens Per Watt		
LED Module	Optic (Reflector)	
Lumens/CRI/Wattage	M40	M60
700/98/12	33	56
1000/83/12	50	72
1000/98/17	35	51
1500/83/15	52	75

Absolute range of values are +/- 10% of typical value, and are for all color temperatures

LED Module	700/98/12	1000/83/12	1000/98/17	1500/83/15
Lumens/CRI/Wattage SKU Code	07-98	10-83	10-98	15-83
Nominal Fixture Power (+/- 20%), Watts	12	12	17	15
Maximum Inrush Current Amps	10	10	10	10
Minimum Power Factor	0.92	0.92	0.92	0.92

Inrush current is instantaneous current drawn by the LED only when fixture is initially powered on or instantaneously changed from full dim to full bright. For more details see Dimming Application Sheet, IS-0119.

MAR-S2 • OPTICS

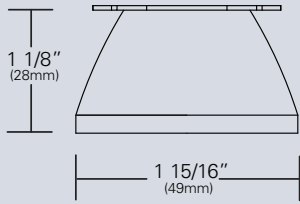

M40 REFLECTOR (49mm/40°)

Computer designed polycarbonate specular optic. Tool-less, twist and lock installation.

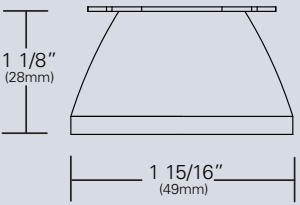

M60 REFLECTOR (49mm/60°)

Computer designed polycarbonate specular optic. Tool-less, twist and lock installation.

MAR-S2 • PHOTOMETRIC DATA

LED RATING: 15-83

M40 49mm DIA Optic

Beam Spread (minimum) **40°**
Center Beam Candlepower **2000**
CRI **83**

M60 49mm DIA Optic

Beam Spread (minimum) **60°**
Center Beam Candlepower **1400**
CRI **83**

LED RATING: 10-98

M40 49mm DIA Optic

Beam Spread (minimum) **40°**
Center Beam Candlepower **1482**
CRI **98**

M60 49mm DIA Optic

Beam Spread (minimum) **60°**
Center Beam Candlepower **1009**
CRI **98**

LED RATING: 15-83

M60 (60°) **M40 (40°)**

All Max. Footcandles at 0° Beam Axis

1400	2000
350	500
156	222
88	125
56	80
39	56
29	41
22	31
17	25
14	20
12	17
10	14
8	12
7	10
6	9
5	8
5	7
4	6
4	6
4	5
3	5
3	4
3	4
3	4
2	3
2	3

All Distances in Feet

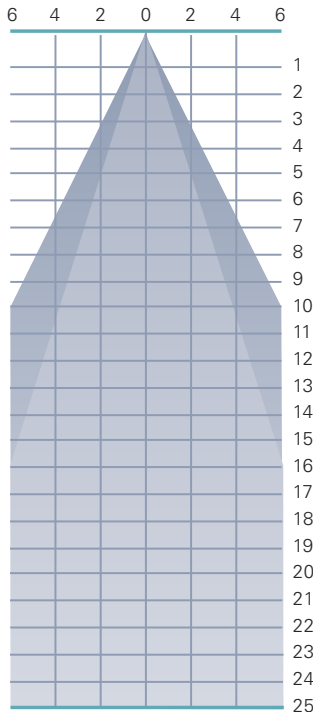

Photometric Data based on LED Rating: 15-83 (1500 Lumens/83CRI/15watts)

LED RATING: 10-98

M60 (60°) **M40 (40°)**

All Max. Footcandles at 0° Beam Axis

1009	1482
252	371
112	165
63	93
40	59
28	41
21	30
16	23
12	18
10	15
8	12
7	10
6	9
5	8
4	7
4	6
3	5
3	5
3	4
3	4
2	3
2	3
2	3
2	3
2	3
2	2

All Distances in Feet

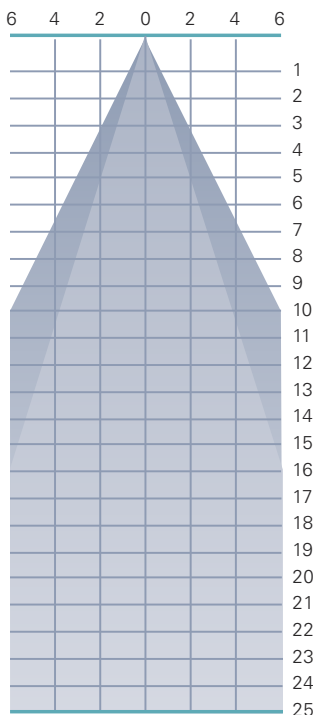

Photometric Data based on LED Rating: 10-98 (1000 Lumens/98CRI/17watts)

MAR-S2 • ACCESSORIES

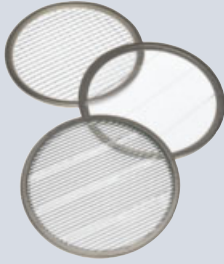

SPREAD LENSES AND BEAM SOFTENER

No.	Description	% of Light Transmission
990	Spread Lens/Clear	83 (5°X 50°)
992	Spread Lens/Clear	85 (5°X 30°)
995	Spread Lens/Clear	83 (50°X 50°)
996	Spread Lens/Clear	86 (45°X 50°)
998	Beam Softener/Clear	80 (45°X 45°)

BACKER RING AAA

Stainless steel ring to hold gel when no other size AAA accessories are being used.

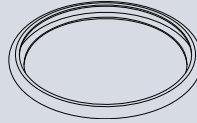

LOUVER HEX AAA

1/8" thick Hexcell black metal louver used for thin profile.



¹LIGHT BLOCKING SCREENS AAA

Stainless steel mesh screens used alone or in combinations will block from approximately 20% to 90% of the transmitted light without changing color temperature of the light.



No.	% of Light Blocked
AAA801S	20
AAA802S	30
AAA803S	40

1. Figures vary based upon LED Module/Optic being used and relationship of screen(s) to LED Module/Optic and to each other.

MAR-S2 • GELS

As the foremost innovator in accent lighting, LSI offers a complete range of pre-cut Gels to modify the spread and color of light for the LumeLEX LED Series.



LumeLEX® SPREAD GELS

Size: AAA (60 mm diameter)	Spread Gel
GEL-L1-AAA	1° Spread Gel
GEL-L5-AAA	5° Spread Gel
GEL-L10-AAA	10° Spread Gel
GEL-L20-AAA	20° Spread Gel
GEL-L30-AAA	30° Spread Gel
GEL-L40-AAA	40° Spread Gel
GEL-L60-AAA	60° Spread Gel
GEL-L80-AAA	80° Spread Gel
GEL-L30B5-AAA	30° by 5° Spread Gel
GEL-L40B2-AAA	40° by 0.2° Spread Gel
GEL-L60B1-AAA	60° by 1° Spread Gel
GEL-L60B10-AAA	60° by 10° Spread Gel
GEL-L75B45-AAA	5° by 45° Spread Gel
GEL-L90B60-AAA	90° by 60° Spread Gel
GEL-R101-AAA	Beam Softener

LumeLEX® COLOR GELS

Size: AAA (60 mm diameter)	Gel Color	Size: AAA (60 mm diameter)	Gel Color
GEL-R2-AAA	Bastard Amber	GEL-R312-AAA	Canary
GEL-R7-AAA	Pale Yellow	GEL-R3204-AAA	Half Blue
GEL-R12-AAA	Straw	GEL-R331-AAA	Shell Pink
GEL-R13-AAA	Straw Tint	GEL-R383-AAA	Sapphire Blue
GEL-R14-AAA	Medium Straw	GEL-R397-AAA	Pale Grey
GEL-R21-AAA	Golden Amber	GEL-R2001-AAA	Storaro Red
GEL-R25-AAA	Orange Red	GEL-R2004-AAA	Storaro Green
GEL-R26-AAA	Light Red	GEL-R2009-AAA	Storaro Violet
GEL-R27-AAA	Medium Red	GEL-R3202-AAA	Full Blue
GEL-R57-AAA	Lavender	GEL-R3206-AAA	Third Blue
GEL-R62-AAA	Booster Blue	GEL-R3216-AAA	Eighth Blue (Boosts 3200K to 3300K)
GEL-R71-AAA	Sea Blue	GEL-R3318-AAA	Tough 1/8 Minusgreen
GEL-R72-AAA	Azure Blue	GEL-R3410-AAA	Roscosun (1/8 CTO) (Reduces 5500K to 4900K)
GEL-R91-AAA	Primary Green	GEL-R3441-AAA	Full Straw (CTS)
GEL-R97-AAA	Light Grey	GEL-R3443-AAA	Quarter Straw (CTS)
GEL-R98-AAA	Medium Grey	GEL-R4330-AAA	CalColor 30 Cyan
GEL-R101-AAA	Light Frost	GEL-R4415-AAA	CalColor 15 Green
GEL-R104-AAA	Tough Silk	GEL-R4490-AAA	CalColor 90 Green
GEL-R119-AAA	Lt. Hamburg Frost	GEL-R4860-AAA	CalColor 60 Pink
GEL-R121-AAA	Blue Diffusion	GEL-R4890-AAA	CalColor 90 Pink
GEL-R305-AAA	Rose Gold	GEL-R4930-AAA	CalColor 30 Lavender

COLOR MEDIA

COLOR FILTERS

As the foremost innovator in accent lighting, LSI offers a complete range of permanent fade-free glass color filters, which are available in nine stock diameters. All glass color filters are rimmed in a seamless aluminum ring and are slotted for heat expansion.

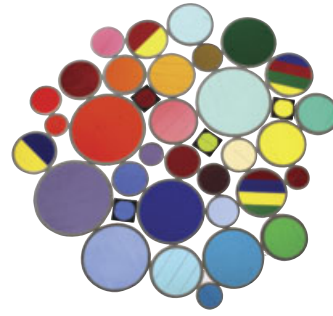

Size	Diameter	LSI Fixture Series	No.	Color	% of Light Transmission
AAA	2 3/8"	LumeLEX® 2020/2030/2031/2038, SSLCX16, SSL260, LumeLEX MAR-S	902	Medium Pink	36
			903	Deep Pink	37
			904	Flesh Pink	73
ZM	2 13/16"	LZ Zoom	906	Pale Lavender	14
			907	Surprise Pink	19
AA	3"	LumeLEX® 2024 (with LX2024-Holder or LX2024-Barndoor), LumeLEX® 2044, LumeLEX 2048	908	Lilac	21
			910	Warm Red	10
			911	Strawberry	6
			912	Ruby	4
A	3 1/2"	LumeLEX® 2060, SSL230, SSLCX30, SSLGR30CL, SSLGR36	913	Magenta	1
			914	Light Amethyst	25
B	4 1/4"	LumeLEX® MAR-L	915	Medium Amethyst	16
			916	Deep Amethyst	4
			917	Olive	18
C	4 3/4"	LumeLEX® 2084, LumeLEX® 2088, SSL238, SSLCX36, SSLCX38, SSLGR38CL	918	Light Green	68
			920	Medium Green	25
			921	Deep Green	7
			922	Silver green	65
			923	Yellow Green	49
			924	Emerald Green	12
			925	Light Turquoise	68
			926	Medium Turquoise	40
			927	Deep Turquoise	17
			928	Light Blue	34
			930	Medium Blue	3
			932	Daylight	59
			933	Gene Moore Blue	18
			936	Grey	56
			937	Light Blue Green	17
			939	Light Amber	68
			940	Medium Amber	48
			941	Deep Amber	43
			942	Straw	78
			943	Gold	87
			944	Canary Yellow	84
			945	Lemon	81
			946	Pumpkin	32
			947	Tangerine	20
			948	Orange	23
			949	Pink Gold	54
			950	Bronze	48
			951	Brass	11
			952	Autumn Tan	11
			953	Leaf Brown	19
			954	Butter Pecan	3
			955	Toasted Almond	1

Notes:

1. Values given are approximate due to slight variations in glass color and thickness.

COLOR MEDIA

DICHROIC COLOR FILTERS

In addition to our complete line of glass color filters, LSI now offers dichroic glass color filters that achieve purer, more saturated, richer color by selective wavelength transmission. Since these filters reflect rather than absorb the unwanted color wavelengths, a higher intensity of colored light can be obtained with fewer or lower wattage fixtures. In addition, this selective transmission allows for very accurate color matching from filter to filter.

All standard LSI filter sizes are available in a wide palette of well chosen dichroic colors that can be used with all LSI fixtures that accept accessories.

LSI dichroic glass color filters have the added benefit of being rimmed for extra durability to allow for frequent usage without fear of breakage or edge chipping.

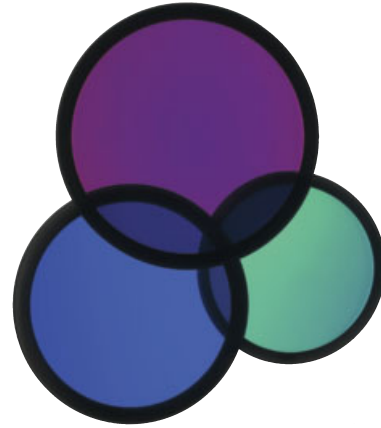

Size	Diameter	LSI Fixture Series	Technical Data	No.	Color	% of Light Transmission
AAA	2 3/8"	LumeLEX® 2020/2030/2031/2038, SSLCX16, SSL260, LumeLEX MAR-S	Dichroic color filters are created in a vacuum chamber by multi-layer vapor deposits of different minerals onto low expansion, chemically resistant Borosilicate glass.	2001	Light Pink	69
ZM	2 13/16"	LZ Zoom	Deposits are made in alternating layers of varying microscopic thickness which allow very narrow color wavelengths to be selectively transmitted and all other wavelengths to be reflected.	2002	Medium Pink	43
AA	3"	LumeLEX® 2024 (with LX2024-Holder or LX2024-Barndoor), LumeLEX® 2044, LumeLEX 2048	LSI does not recommend using dichroic color filters with lamps or fixtures that have beam spreads greater than 40° because a secondary color aura is created by the wide angular transmitted wavelengths that are different than the desired color wavelength.	2003	Hot Pink	11
A	3 1/2"	LumeLEX® 2060, SSL230, SSLCX30, SSLGR30CL, SSLGR36	Since there is mainly transmission and reflection of the color wavelengths by the dichroic filter and very little absorption, the dichroic filter can be used with many high temperature lights that normally would not accept color filters.	2004	Pale Pink	55
B	4 1/4"	LumeLEX® MAR-L		2010	Deep Magenta	29
C	4 3/4"	LumeLEX® 2084, LumeLEX® 2088, SSL238, SSLCX36, SSLCX38, SSLGR38CL		2011	Lavender	24
				2012	Vivid Magenta	31
				2013	Lavender Accent	48
				2014	Lilac	37
				2015	Purple Fusion	12
				2020	Sky Blue	39
				2021	Sea Blue	39
				2022	Cyan	33
				2023	Light Blue Green	30
				2024	Primary Blue	24
				2025	Medium Red Blue	15
				2026	Deep Purple	16
				2027	Peacock Blue	53
				2028	Mediterranean Blue	20
				2029	Boost Blue	51
				2040	Light Yellow Green	64
				2041	Fern Green	47
				2042	Turquoise	35
				2043	Primary Green	31
				2044	Industrial Green	64
				2050	Yellow	80
				2051	Amber	71
				2052	Amber Blush	38
				2053	Bastard Amber	71
				2054	Goldenrod	63
				2055	Bright Straw	56
				2060	Medium Orange	51
				2061	Orange	44
				2070	Flame Red	27
				2071	Primary Red	25