

SURFACE TRACK (277V) • INSTALLATION

General Notes

When installing or using this track system, basic safety precautions should always be followed, including the following: Read all instructions. Do not install this track in damp or wet locations. Do not install any part of the track system less than eight feet from floor. Do not install any fixture assembly closer than six inches from any curtain or similar combustible material. Disconnect electrical power before adding to or changing the configuration of the track. Check with a qualified electrician. Do not attempt to energize anything other than lighting track fixtures on the track. To reduce the risk of fire and electric shock, do not attempt to connect power tools, extension cords, appliances and the like to the track. Install as per NEC and local codes. Save these instructions.

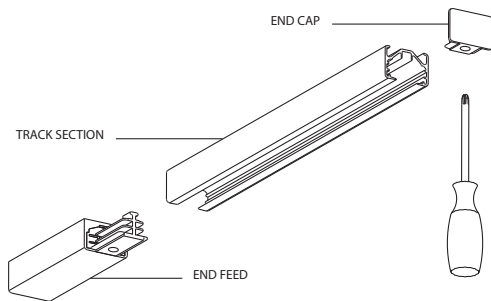

Assembling

Insert End Cap, End Feed or any other Joiner/ Feeder completely into Track Section and tighten the recessed Phillips head screw. Do not use excessive force when inserting components into Track Section.

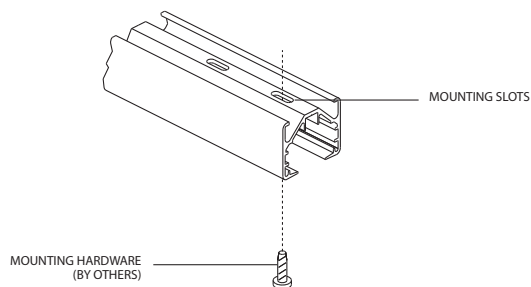

Mounting

Fasten track directly to surface through pre-punched mounting slots with hardware (by others) capable of withstanding a 50 lb. pull. Mount track in compliance with NEC Lighting Track Article #410-101 (Installation), #410-104 (Fastening) and any other applicable codes. To prevent distortion of the track opening which may prevent insertion of fixture fittings do not over tighten mounting screws. LSI recommends a minimum of two mounting points per section of track. LSI track can be mounted on centers up to 6'-0".

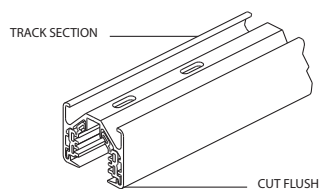

Field Cutting

LSI track can be easily field cut using a sharp hacksaw or a chop saw with a blade for non-ferrous metals, such as Oldham commercial carbide series metal blade. Together, cut the aluminum track, Noryl™ insulation, and copper with one straight cut. All pieces must be exactly the same length. Be sure to remove any burrs on the aluminum or the copper as this may affect the electrical and mechanical interconnection of components to track. Do not cut track to less than one foot in length.

SURFACE TRACK (277V) • INSTALLATION

Electrical

Remove the Lexan™ cover from any End Feed or Joiner/Feeder, bring wires through combination 1/2, 3/4 U.S. trade size knock-out (.875 diameter [22mm], 1.125 diameter [29mm]) in feed plate and attach conductors to identified terminals. Joiner/Feeders can be electrically field modified after removal of Lexan™ cover by rerouting internal pre-wired jumpers.

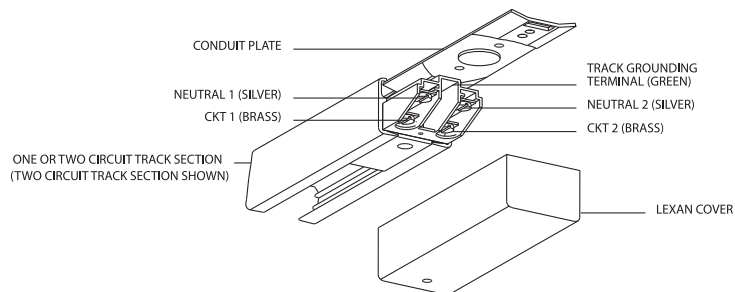

Additional Circuits

LSI Track has integral wiring channels for six additional #12 THHN wires to create three additional 20 amp circuits with separate neutrals. Place conductors in wiring channels and slide raceway covers into track prior to mounting.

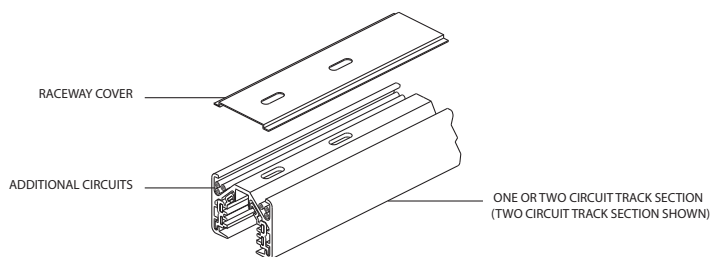

Installing LSI Fixtures

LSI 277 volt fixtures always have a **red rotor** to identify them. To insert a fixture fitting into the track, the switch must be in the "off" position, with the handle open. Insert the fixture fitting straight up into the track until it seats evenly, close handle completely, switch on. If using one circuit track, make sure that the brass contacts which protrude from the side of the fixture fittings are inserted facing the copper busbars. If using two circuit track, inserting the fixture fitting in one direction will connect to circuit one. Removing and reversing the direction of the fitting will connect to circuit two.

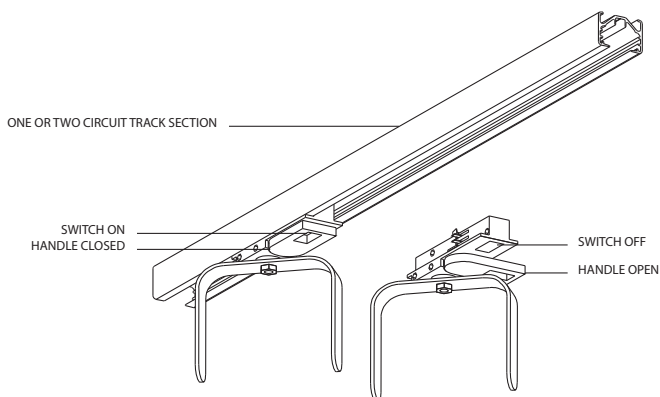

TYPICAL WIRING DIAGRAMS

Diagrams apply to 120V Surface Track, 277V Surface Track and Recessed Track Systems

Single Circuit

Straight Joiner/Feeder

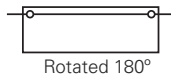
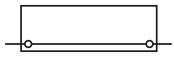

L Joiner/Feeder

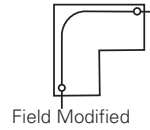
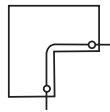

Notes:

All diagrams shown are installed view, not RCP.

Except as noted, all modifications can be done simply and quickly on the job with a Philips and straight blade screwdriver

T Joiner/Feeder

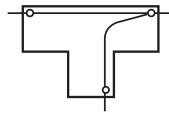
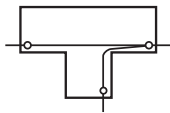
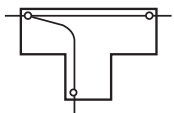
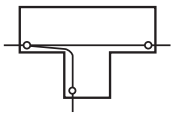

X Joiner/Feeder

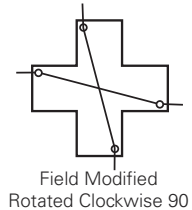
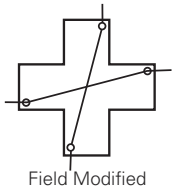
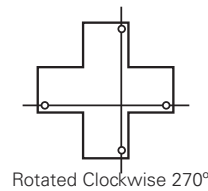
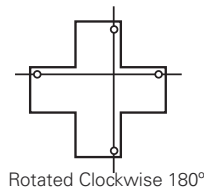
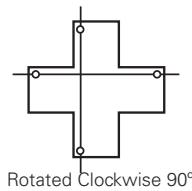
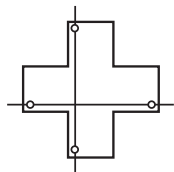

Flexible Joiner

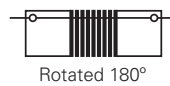

Two Circuit

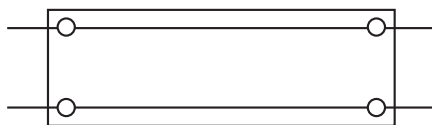

Straight Joiner/Feeder



T Joiner/Feeder

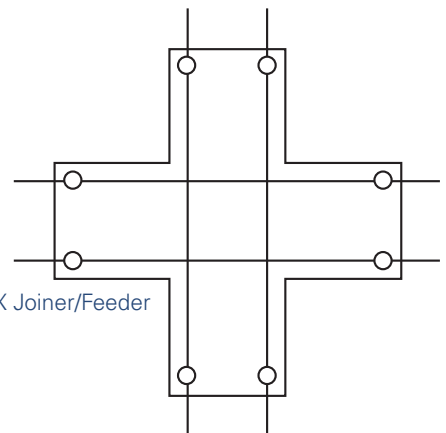

X Joiner/Feeder

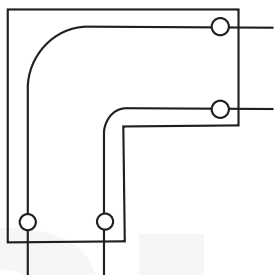

L Joiner/Feeder



Flexible Joiner*

* Prewired internal jumpers cannot be modified.